

PRESENTED BY



AUTOMOTIVE



# PLASTICS IN ELECTRIC & AUTONOMOUS VEHICLES

Troy, MI • April 16-19, 2023

Powered by SPE Automotive Division

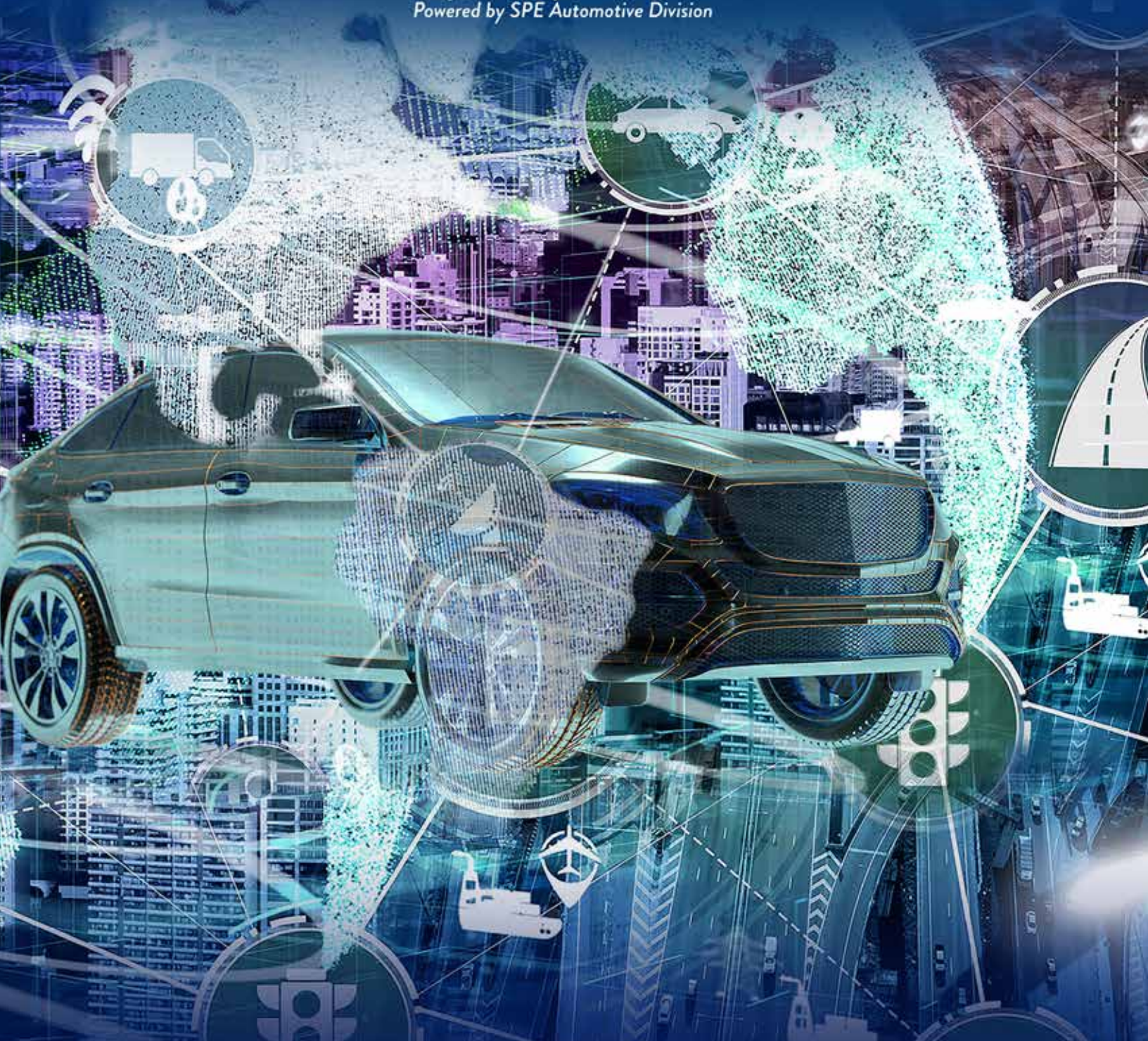

<https://speautomotive.com/plastics-in-electric-autonomous-vehicle-conference/>

DETROIT MARRIOTT TROY • 200 W BIG BEAVER • TROY MI 48084

CHEMISTRY THAT MATTERS™



# ACCELERATING CHANGE

Our mission is to help accelerate change towards an electric future. We are doing it through BLUEHERO™ – a strategic initiative backed by proven thermoplastic materials, trusted experts and global resources.

Under BLUEHERO, we are providing the materials, solutions and expertise to help speed up the development and enhancement of EV battery systems.

Helping industry to deliver the full benefits of next-generation vehicles for the world. This is 'Chemistry that Matters™'.

Scan to learn more  
about BLUEHERO



[www.SABIC.com](http://www.SABIC.com)

© 2023 Copyright by SABIC. All rights reserved.

# WELCOME

TO THE

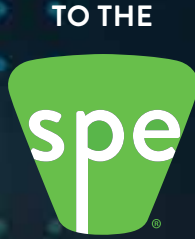

**EAV 2023**

**PLASTICS IN ELECTRIC &  
AUTONOMOUS VEHICLES**

**Troy, MI • April 16-19, 2023**

*Powered by SPE Automotive Division*

Welcome to the 2nd SPE Annual Plastics in Electric and Autonomous Vehicle (EAV) Conference. The EAV Conference is sponsored by the Society of Plastics Engineers Automotive Division, and it is the only conference of its kind to bring various plastics applications in Electric or Autonomous vehicles in one event.

The EAV conference is supported by a great planning team from SPE Automotive Division volunteer members. This group of volunteers worked very hard in the past 12 months to bring this conference to reality, and we are grateful to their dedication. If you see any one of these committee members during the conference, please stop and say hi to them and thank them for their effort and dedication to SPE and EAV Conference. With the continued leadership of Dr. Norm Kakarala and Dr. Suresh Shah as the co-chairs of the technical committee, we have a great two and a half day conference planned for you.

**Five Superb Keynote Speeches, one Panel Discussion with seven expert panelists on “Thermal Runaway Protection”, 69 Technical Presentations, Dozen Posters from Local High School Students and more than Dozen from College Students on Plastics for EAV and 35 sponsors booths** in 2 ½ days. We are grateful to have a great number of sponsors, especially SABIC, Celanese, ENTEC and Lotte Chemical, our Platinum sponsors for this conference. Please take your time and visit all the sponsors booth and thank them for their participation. Whether you’re here to present a paper, exhibit your company’s products and/or services, or to find solutions to pressing Electric or Autonomous Vehicle engineering challenges, we hope you find what you’re looking for at our EAV conference. We know this conference will help you to better understand the new trends and market forces at work in the EAV industry today. Not only will you leave here better informed than when you arrived by visiting sponsors and attending our technical presentations, but you also should leave with lots of new professional contacts to seek help when needed. We built numerous networking opportunities into our program. Two lunches and two evening receptions plus morning and afternoon breaks so you can ask questions, meet new people, grab a beverage, and avail yourselves of the tremendous amount of collective automotive-plastics knowledge assembled at this venue. We’d like to acknowledge all the effort of our committee of volunteers who helped to bring this program to you. Our team has been hard at work for the last twelve months. If there’s something we could do better, please don’t hesitate to tell a member of our committee so we can discuss it in our post conference continuous improvement meeting. If there’s something we did right, please don’t hesitate to tell us that too. We’re always striving to make our events better year after year.

Sincerely,

*Dr. Sassan Tarahomi*

Dr. Sassan Tarahomi,  
CTO Alterra Holdings  
SPE Automotive Division Chair  
EAV Conference Chair



**CONFERENCE  
CHAIR**

**Dr. Sassan Tarahomi,**  
Alterra Holdings



# POWERING YOUR EV SOLUTIONS

Technical Expertise Delivering  
Resin Solutions

- ➔ Interior
- ➔ Exterior
- ➔ Powertrain
- ➔ Light-Weighting

---

Your full service supplier through all  
phases of your project



Design

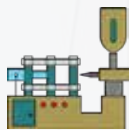

Processing

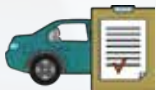

Testing



Manufacturing

**Let's Get Started!**

---

[EntecPolymers.com](http://EntecPolymers.com)



# 2023 PLASTICS IN EAV CONFERENCE

# TECHNICAL

## PROGRAM HIGHLIGHTS

The SPE Automotive Division Board Members have joined the Conference Organization Team and provided outstanding support with passion and dedication. Their network of industry contacts delivered great benefit to the conference to feature 5 Keynotes from industry executives, 7 technical specialists to join industry panel to address a critical issue of “Thermal Runaway – Scenarios and Solutions”, and a superb Technical Program. The conference organizers deserve many accolades for doing great service to the industry.

The technical program features **8 technical sessions with 69 presentations** covering use of plastics in Electric and Autonomous Vehicles at this conference. We used **three concurrent sessions** in scheduling the presentations. A file with short (about 50 words) abstracts of these talks is provided in the **Conference Proceedings** File on the SPE Automotive Division [www.SPEAutomotive.com](http://www.SPEAutomotive.com) website for your convenience in selecting which of the 3 talks at any given time you may want to attend.

The three session rooms are adjacent to each other making it convenient if you prefer to change from one session to the other. **Short synopsis of talks in each session hall are displayed on the large screen of the monitors near the entrance of the hall.** Copies of all presentation files are provided on the website ([www.SPEAutomotive.com](http://www.SPEAutomotive.com)) and accessible for all conference participants.

Two or three Co-Chairs for each of the 8 sessions have shared the responsibility in recruiting quality presentations and work-out all the logistics in gathering all required documentation in a timely manner. The session chairs have the complete autonomy in running their session for providing greater value to the participants. We are fortunate to recruit superb quality presentations on cutting edge technologies. **The Program Schedule provides details of the session chairs and their affiliations.**

We value the experience and wisdom of all our session chairs in selecting the topics for their session and recruiting specialists in the industry to discuss those topics. Most of the session chairs are currently serving as members of the Automotive Division Board. **We are grateful for their continued guidance and support.**

Session Chair’s mission is to ensure both the presenters and the participants have pleasant experience and receive enhanced value with the interactions. Based on the available time after the presenter concludes the talk, the session moderator will facilitate discussions with Questions and Answers. **We urge you to engage the presenters in discussion for elaboration of details and improved clarity of the subject discussed.** The presenters will be delighted to address any questions and gratified with the interest you showed in asking for clarification. Further the value of the conference improves with the dialogue and discussion during the conference.

We believe strongly that we gain greater value with personal interactions with presenters at a conference than simply listening to the talks. Please seek out the presenters during breaks, lunches or receptions and get to know and engage them in discussions for improved learning. Remember both you and the presenter have a commonality of interest on the same technical topic.

Thank you for supporting the conference with your participation. **Please provide us feedback** on what you liked and how we can improve. Further we seek your support for next year event in volunteering to organize a session (by recruiting presenters) or join the organizing committee (for managing sponsorships and exhibits).

### TECHNICAL PROGRAM CO-CHAIRS:

**Dr. Norm Kakarala**, SPE Fellow and Honored Service Member (HSM)

**Dr. Suresh Shah**, SPE Fellow, HSM and Inductee on Plastics Hall of Fame



### TECHNICAL CO-CHAIR

**Dr. Norm Kakarala**  
Inteva Products LLC  
- retired



### TECHNICAL CO-CHAIR

**Dr. Suresh Shah**  
Delphi Corp - retired

# Solutions. Electrified.



When it comes to materials that drive future mobility, ask the experts. Celanese has application development and technical support plus a robust portfolio of polymer-enabled products that help realize components that improve:

- Durability
- Lightweighting
- Connectivity
- Safety
- Range

For OEMs and Tier suppliers looking for a single source to answer a wide range of needs in battery, e-motor, and ADAS applications, call Celanese.

**We are: Solutions. Electrified.**

 **Celanese**  
The chemistry inside innovation™

# 2023 PLANNING COMMITTEE



## PLASTICS IN ELECTRIC & AUTONOMOUS VEHICLES

Troy, MI • April 16-19, 2023  
Powered by SPE Automotive Division

### CONFERENCE CHAIR

Dr. Sassan Tarahomi, Alterra Holdings

### TECHNICAL PROGRAM CHAIR

Dr. Norm Kakarala, Inteva Products LLC (Retired)  
Dr. Suresh Shah, Delphi Corp (Retired)

### CONFERENCE SUPPORT

#### DATABASE COORDINATOR

Bill Coy, Mankiewicz Coatings, LLC

#### TREASURER

Jitesh Desai, Inteva (Retired)

#### SPONSORSHIP SUB-COMMITTEE

Rodrigo Orozco, Celanese  
Keith Siopes, EMS Chemie

#### SPONSOR

Dan Dowall, Ineos Composites  
Neil Fuenmayor, LyondellBasell

#### STUDENT POSTER COORDINATOR

Chuck Jarrett, The Materials Group

#### SESSION COUNCILOR/ STUDENT ENGAGEMENT

Alper Kiziltas, Amazon

#### COMMUNICATION LEAD

Dhanendra Nagwanshi, SABIC

#### KEYNOTE SPEAKER CHAIR

Tom Pickett, General Motors

#### OEM & KEYNOTE COMM.

Umesh Gandhi, Toyota Tech. Ctr.  
Dave Helmer, General Motors  
Jeffrey Helms, Celanese  
Ramesh Iyer, ICIS  
Manoj Patnala, Rivian

#### SPONSOR & KEYNOTE PRESENTER

Dean Stevenson, Rivian

#### MEETING COORDINATOR/ SPONSOR

Leslie Preston,  
Mankiewicz Coatings, LLC

#### REGISTRATION PROGRAM

Richard Umemoto, Magna Exterior

#### REGISTRATION DAY OF CONFERENCE

David Patel, Mitsubishi Chemicals  
(Retired)

#### ASSIST FOR DAY OF CONFERENCE

Ramesh Iyer, ICIS  
Karen Rhodes-Parker,  
SPE Detroit - TPO

#### CONTRACTOR (PROGRAM BOOK)

Jill Houser, JPI Creative Group

### TECHNICAL SESSIONS & SESSION CHAIRS

#### > BATTERY AND THERMAL MANAGEMENT SYSTEMS

Dhanendra Nagwanshi, SABIC  
Dr. Jeff Helms, Celanese Corp.  
Maggie Baumann, PPA/Pinfa NA

#### > MANUFACTURING ENABLING TECHNOLOGIES

David Kosse, Ascend Performance Materials  
Steve Vanloozen, Lotte Chemical

#### > SUSTAINABILITY AND CARBON NEUTRALITY

Dr. Rohit Srivastava, Amazon  
Drew Geda, Hyundai-Kia America

#### > ADVANCED DRIVER ASSISTANCE SYSTEM (ADAS)

Dr. Rodrigo Orozco, Celanese  
JP Wiese, SABIC

#### > EVOLUTION OF EXTERIORS AND LIGHTING

Tom Pickett, General Motors  
Volker Plehn, SABIC  
Mark Lapain, Advanced Composites

#### > EVOLUTION OF INTERIORS

Dr. Rose Ryntz, Ryntz & Associates  
Jeff Crist, Ford Motor Co.  
Jim Keller, Mankiewicz Coatings LLC

#### > MATERIAL INNOVATIONS

Mike Shoemaker, Borealis  
Paula Kruger, Ascend Performance Materials  
Sunit Shah, LyondellBasell

#### > NOISE, VIBRATION AND SEALING

Andrea Frey, General Motors  
Dr. Xian Jiang, Dow



# A Better World Through Chemistry

A more comfortable daily life  
and a greener environment

We're creating a future that benefits  
both people and nature



A sustainable packaging lowering CO<sub>2</sub> emissions: utilizing chemically decomposed waste PET

**C-rPET**



Reducing green house gas emissions through carbon capture & utilization

**CCU**



Creating an eco-friendly hydrogen system from production to transportation

**HYDROGEN BUSINESS FOR SUSTAINABLE MOBILITY**



Producing electrolytes for secondary batteries from PE separators to anode & cathode foil

**EV BATTERY MATERIALS**

At LOTTE Chemical family, we're creating a harmonious world for people and nature







# EAV 2024

PLASTICS IN ELECTRIC &  
AUTONOMOUS VEHICLES

Troy, MI • April 15-17, 2024

*Powered by SPE Automotive Division*



# MONDAY, APRIL 17, 2023

All times EST USA

7:00 AM  
8:15 AM  
8:30 AM  
8:45 AM  
9:15 AM  
9:30 AM  
10:00 AM

## REGISTRATION & CONTINENTAL BREAKFAST: SPONSORED BY SPE

**WELCOME REMARKS:** Conference Chair: **Dr. Sassan Tarahomi**, Alterra Holdings

**TECHNICAL PROGRAM HIGHLIGHTS:** **Dr. Norm Kakarala / Dr. Suresh Shah**

**KEYNOTE SPEAKER:** **Jamie Brewer**, GM Executive Chief Engineer Electric SUVs, **GM's EV/AV Strategy and Innovation**

**PLATINUM SPONSOR REMARKS: SABIC & CELANESE**

**KEYNOTE SPEAKER:** **Dean Stevenson**, Rivian Senior Director of Interiors, **Systematizing Sustainability**

## BREAK: SPONSORED BY SPE

### CONFERENCE HALL - I

**BATTERY AND THERMAL MANAGEMENT SYSTEMS**  
**Dhanendra Nagwanshi**, SABIC  
**Dr. Jeff Helms**, Celanese Corp.  
**Maggie Baumann**, PPA/Pinfa NA

**Fire Protection Materials for EVs: Technology, Trends, and Markets**  
**Dr. James Edmondson**, IDTechEx

**Battery Enclosure Materials Screening Tests Torch and Grit (TaG) and Battery Enclosure Material Screening (BEMS)**  
**Ken Vessey**, UL Solutions

**The Physics of Cell Venting Failures: Beyond UL2596 and the Need for Venting Management**  
**Brian Engle**, Amphenol

### CONFERENCE HALL - II

**MANUFACTURING ENABLING TECHNOLOGIES**  
**David Kosse**, Ascend Performance Materials  
**Steve Vanloozen**, Lotte Chemical

**Innovative Hybrid Molding in Color**  
**Dan Rozelman**  
Kraus Maffei

**HR Resistant PK for Cooling Systems**  
**Daniel Baek**  
Akro Compounds

**Welding of FRTP for Challenging BEV Applications**  
**Adam Halsband**, Forward Engineering

### CONFERENCE HALL - III

**SUSTAINABILITY AND CARBON NEUTRALITY**  
**Dr. Rohit Srivastava**, Amazon  
**Drew Geda**, Hyundai-Kia America

**Carbon Footprints: The Next Driver in Evolving the Plastics Supply Chain**  
**Joseph Chang**, ICIS Chemicals

**Recyclability of Polypropylene and Polyamide Composites with Basalt Fibers**  
**Dr. Sandeep Tamrakar**  
Ford Motor Company

**LG Chem Chemical Recycling Process of Polycarbonate**  
**BK Jeon**, LG Chem

10:30 AM  
11:00 AM  
11:30 AM  
12:00 PM

## LUNCH: SPONSORED BY SABIC

### BATTERY AND THERMAL MANAGEMENT SYSTEMS

**Advanced Insulation for High Voltage Electric Motor Winding**  
**Dr. Monoj Ghosh**, Eaton Corporation

**Role of Thermoplastics in Accelerating EV Battery Pack Development**  
**Dave Sullivan**  
SABIC

**Fire Safety and the Role of FR Additives**  
**Maggie Baumann**  
Performance Polymers and Additives / Pinfa North America

**The Growing Role of FR Additives In EVs and AVs**  
**Dr. Subra Narayan**, Clariant

### MANUFACTURING ENABLING TECHNOLOGIES

**Compounding with AI**  
**Saeed Arabi**  
Alterra Plastics

**Optimized Compounds and Blowing Agents for Technical Applications**  
**Thilo Stier**  
Akro Compounds

**Toolless Fabrication of TPU with Additive Manufacturing**  
**Rebecca Fecteau**, BASF  
**Steve Richardson**, Forecast3D

**Advanced Composites Manufacturing Solutions for the AV and EV Industry**  
**Anand Bora**, MOLDEX3D

### SUSTAINABILITY AND CARBON NEUTRALITY

**Reclaimed Carbon Fiber Based Sustainable Solutions for Lightweight Electric Vehicle Structures**  
**Soma S. Bobba**, SABIC

**Bazer Reinforced Polyamide-6 Composites with Hemp Hurd Biochar Filler for Automotive Applications**  
**Mohammad Mezbah UI Hoque**  
Washington State University

**Composite Laminates Thermoformed from Wood-Based Prepregs for Interior Automotive Applications**  
**Avishek Chanda**, Washington State University

**PCR and Bio Based TPO/TPE for Electric Vehicles**  
**Dr. Arash Kiani**, Alterra Holdings

1:30 PM  
2:00 PM  
2:30 PM  
3:00 PM  
3:30 PM

## BREAK: SPONSORED BY SPE

### BATTERY AND THERMAL MANAGEMENT SYSTEMS

**Large, Safe, Lightweight, and Multifunctional Thermoplastic Enclosures for EV Battery Packs**

**Fred Chang**  
SABIC

**High Energy Density Battery Pack Concept**  
**Pat Granowicz**  
Celanese

**Polyamide Technologies Addressing Thermal Runaway Challenges in EVs**  
**Kai Becker**  
Ascend Materials

### ADVANCED DRIVER ASSISTANCE SYSTEM (ADAS)

**Dr. Rodrigo Orozco**, Celanese  
**JP Wiese**, SABIC

**SABIC Specialties' Solutions for Automotive Radar Sensors**  
**Dr. Jeff Xu**, SABIC

**Material, Process and Design effects on Warp in Camera Brackets**  
**Brandon Bouchard**, Celanese

**Optimizing Radar Performance of Exterior Trim**  
**Carlos Pereira**  
SABIC

### EVOLUTION OF EXTERIORS AND LIGHTING

**Tom Pickett**, General Motors  
**Volker Plehn**, SABIC  
**Mark Lapain**, Advanced Composites

**Material Solutions and Innovations for Exterior Panels**  
**Volker Plehn**, **Jeff Eshenauer**, SABIC

**Smart Rear & Front Panels by Purposefully Combined Plastic Processing**  
**Michael Fischer**, Engel

**Innovative Protective Coatings for Automotive Exterior Parts, Headlamps and Sensor Covers**  
**Dr. Andreas Haeuseler**, **Adam Keeling**  
Momentive

4:00 PM  
4:30 PM  
5:00 PM

5:30-7:30 PM RECEPTION: CHEESE & WINE SPONSORED BY CELANESE

2023  
ADG  
KE  
AG

# TUESDAY, APRIL 18, 2023

All times EST USA

7:00 AM

## REGISTRATION & CONTINENTAL BREAKFAST: SPONSORED BY SPE

8:15 AM

**WELCOME REMARKS:** Conference Chair: **Dr. Sassan Tarahomi**, Alterra Holdings

8:30 AM

**STUDENT POSTER COMPETITION:** **Chuck Jarrett**, The Materials Group

8:45 AM

**KEYNOTE SPEAKER:** **Jeff Makarewicz**, Group Vice President Technical Resources Toyota North America R&D, *Key Challenges, and Innovative Ideas to Navigate the Road to Future Mobility*

9:15 AM

**PLATINUM SPONSOR REMARKS:** **LOTTE & ENTEC**

9:30 AM

**KEYNOTE SPEAKER:** **Alan Amici**, President and CEO of Automotive Research (CAR), *Assessment of Inflation Reduction (IRA) Act Impacts on North American Electric Vehicle Supply Chain*

10:00 AM

## BREAK: SPONSORED BY SPE

10:30 AM

**PANEL DISCUSSION:** *Thermal Runaway – Scenario and Solutions*

**MODERATORS:** **Dhanendra Nagwanshi**, SABIC; **Dr. Jeff Helms**, Celanese; **Maggie Baumann**, PPA/Pinfa NA

**PANELISTS:** **Ken Vessey**, UL Solutions; **Adam Halsband**, Forward Engineering; **Dave Sullivan**, SABIC; **Brian Engle**, Amphenol; **Michael Blake**, Freudenberg-NOK; **Eric Rask**, ITW Automotive; **Dr. James Edmondson**, IDTechEx

12:00 PM

## LUNCH: SPONSORED BY ENTEC

### CONFERENCE HALL - I

**EVOLUTION OF INTERIORS**  
Dr. Rose Ryntz, Ryntz & Associates  
Jeff Crist, Ford Motor Co.  
Jim Keller, Mankiewicz Coatings LLC

### CONFERENCE HALL - II

**MATERIAL INNOVATIONS**  
Mike Shoemaker, Borealis  
Paula Kruger, Ascend Performance Materials  
Sunit Shah, LyondellBasell

### CONFERENCE HALL - III

**EVOLUTION OF EXTERIORS AND LIGHTING**  
Tom Pickett, General Motors  
Volker Plehn, SABIC  
Mark Lapain, Advanced Composites

1:30 PM

**Dual Cast Process for Designing Circular and Monomaterial for Automotive Interiors**  
**Dr. Murali Reddy**, Cpk Interior Systems

**Advanced Polymers for Electric and Autonomous Vehicles Applications**  
**Dr. Sassan Tarahomi**  
Alterra Holdings

**The Development of Integrated Multifunction EV Grille**  
**George Liu**  
MintH

2:00 PM

**Translucent Foam: Physical Properties and Level of Light Transmittance**  
**Kiego Shimura**  
Sekisui Voltek

**Novel Formulating Strategies for Flame Retardant Automotive Compounds**  
**Jakub Lison**  
ICL Industrial Products

**Innovative Designs and Environmental Solutions to Meet Customer Demands**  
**Brian Guinn, Bob Frazier**  
Valeo

2:30 PM

**Advances in Automotive Interiors**  
**Dr. Pravin Sitaram**  
The Haartz Corporation

**Enabling Thermal Management with Innovations in Thermally Conductive Plastics**  
**Dr. Prabuddha Bansal**  
Celanese

**Material Solutions that Enable Cost and Weight Savings in Automotive Exterior Lighting**  
**Dan Fuller**  
Celanese

3:00 PM

**Needs, Challenges and Film-Based Solutions for Functional Decoparts**  
**Paul Rye**  
Kurz

**High Performance Polymers for Busbars in Power Electronics and e-Motors of Electric Vehicles**  
**Dr. Victoria E. Lee**  
Solvay

**Managing Heat Using Thermally Conductive Polycarbonates to Achieve Weight, Space and Cost**  
**Jim Lorenzo**  
Covestro

3:25 PM

## BREAK: SPONSORED BY SPE

### EVOLUTION OF INTERIORS

**Throwing Your Shoes at Your Car Seat**  
**Aaron Delong**  
HP

### MATERIAL INNOVATIONS

**Next-Gen Automotive Materials to Increase Safety and Reliability in the Electrical Powertrain**  
**Keith Kauffmann**  
Envalior

### NOISE AND VIBRATION

**Andrea Frey, General Motors**  
**Dr. Xian Jiang, Dow**

**Automotive Acoustic Materials: Design for Acoustics & Applications in Electric Vehicles**  
**Jian Pan**, Auria Solutions

4:00 PM

**Mineral-Based Solutions for EAV Plastics and Sustainability**  
**Dr. Saied Kochesfahani**  
IMERYS Performance Minerals

**Next Generation Polyurethane for Internal Battery Structure**  
**Chris Korson**  
BASF

**Absorption and Reflective Properties of a Crosslinked Foam**  
**Keigo Shimura**  
Sekisui Voltek

5:00 PM

**Automotive Acoustic Materials: Design for Sustainability**  
**Jian Pan**  
Auria Solutions

**Bonding to Dielectric Materials in Battery Pack Assembly**  
**Dr. Thomas Clark**  
DuPont Adhesives

**Anti-vibration Polyamide Solutions to Overcome a Multitude of NVH Challenges**  
**Jason Park**  
Ascend Performance Materials

5:30 PM

**Electrification Driven Challenges for Automotive Plastics**  
**Bernd Henkelmann**  
Radici Group

**Conductive Molding Compounds in Fuel Cells and Battery Applications**  
**Mike Kiesel**  
LyondellBasell

**Design for Sustainable Solutions for Carbon Neutrality**  
**Karen Guzman**  
Covestro

6:00-8:00 PM RECEPTION: CHEESE & WINE SPONSORED BY **LOTTE CHEMICAL**

2023 AWARDS

# WEDNESDAY, APRIL 19, 2023

All times EST USA

7:00 AM

**REGISTRATION & CONTINENTAL BREAKFAST: SPONSORED BY SPE**

8:15 AM

**WELCOME REMARKS:** Conference Chair: **Dr. Sassan Tarahomi**, Alterra Holdings

8:30 AM

**KEYNOTE SPEAKER:** **Dr. Kevin Swift**, Senior Economist, ICIS Global Chemicals, *Long-Term Scenarios for Automotive Plastics*

9:00 AM

**RECOGNITION OF STUDENT PARTICIPATION & AWARDS:** **Dr. Sassan Tarahomi**, Alterra Holdings/**Chuck Jarrett**, The Materials Group

9:30 AM

**BREAK: SPONSORED BY SPE**

	CONFERENCE HALL - I	CONFERENCE HALL - II	CONFERENCE HALL - III
	<b>BATTERY AND THERMAL MANAGEMENT SYSTEMS</b> Dhanendra Nagwanshi, SABIC Dr. Jeff Helms, Celanese Corp. Maggie Baumann, PPA/Pinfa NA	<b>SUSTAINABILITY AND CARBON NEUTRALITY</b> Dr. Rohit Srivastava, Amazon Drew Geda, Hyundai-Kia America	<b>NOISE AND VIBRATION</b> Andrea Frey, General Motors Dr. Xian Jiang, Dow
10:00 AM	Trends and Disruptions for Battery Electric Vehicle (BEV) Thermal Management Systems <b>Eric Rask</b> ITW Automotive	Evaluation of Post-Consumer Recycled Polycarbonate for Electric Micromobility Vehicles <b>Dr. Rashed Islam</b> Lyft	Sustainable Composites for Lighter and Flame-Retardant Electric Vehicle Parts: Challenges on Thermal Management and Enclosures for EV Batteries <b>Prof. Amar K. Mohanty</b> Univ. of Guelph, Canada
10:30 AM	Temperature Management Using Thermally Conductive Electrically Insulative (TCEI) Plastic Materials <b>Ray Szparagowski / Sai Sundaraman</b> Freudenberg – NOK Sealing Technologies	High Performance Polyamides for Demanding Battery and Thermal Management Systems <b>Doug Thornhill</b> EMS-GRIVORY	Development of a Multi-Layer Acoustic Package Model for Automotive Acoustics <b>Manoj Thota</b> Dow
11:00 AM	Thermally Conductive Thermoplastic Solutions for EV Battery Pack <b>Somasekhar Bobba</b> SABIC Specialties	Developments in CirculenRecover TPO Compounds with Recycled Feedstocks for Bumper and Exterior Trim Applications of Electric Vehicles <b>Tomik Mouradian</b> , LyondellBasell	Frunk made of Ultra-Silent: Greater Driving Range for Electric Cars <b>Michael Collinsworth</b> Autoneum North America, Inc.
11:30 AM	Zytel® eCool Multilayer Coolant Tube Technology <b>Nate Dumm</b> Celanese	Possibilities for Reducing the Carbon Footprint <b>Thilo Stier</b> Akro Compounds	How Composite e-Motor Mounts Affect EV NVH Performance <b>Ricardo Mercado</b> BASF
12:00 PM	Santoprene® TPV in EV Cooling Hose Applications <b>Paul Zwick</b> Celanese	Advancement in Sensing and Visualization Semiconductor Solutions that Enhance Safety, Comfort and Sustainability <b>Michael Godwin</b> Osram	2nd Generation NVH Zytel™ Hushes the Crowd with Muscle <b>Gabriel Knee</b> Celanese
12:30 PM	<b>CONFERENCE ENDS</b>		

Revision: 9  
Date: April 6, 2023

AGENDA 2023

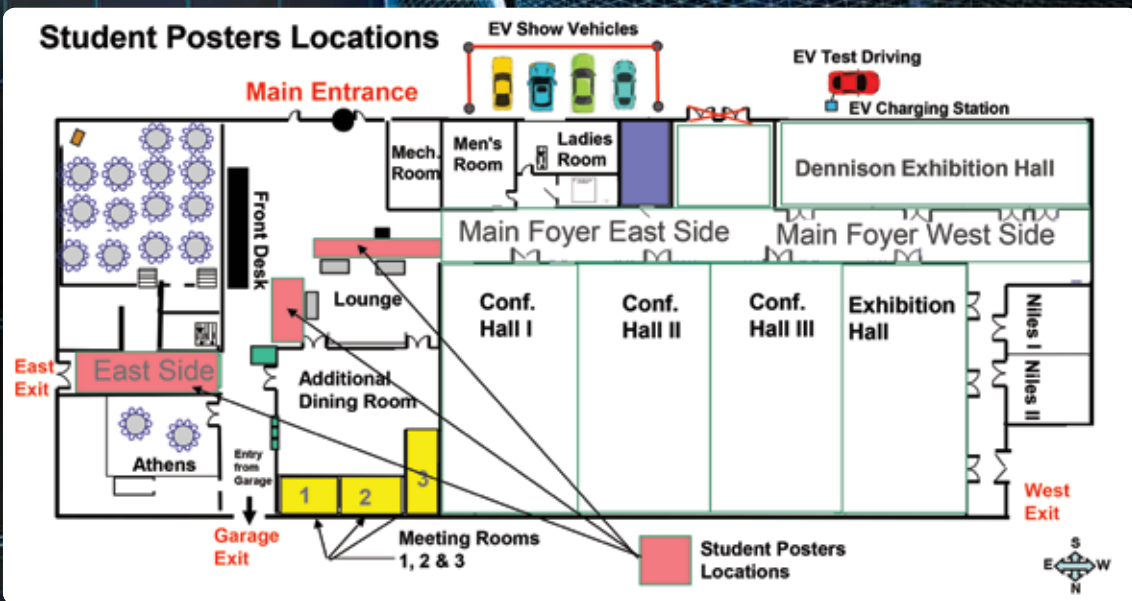
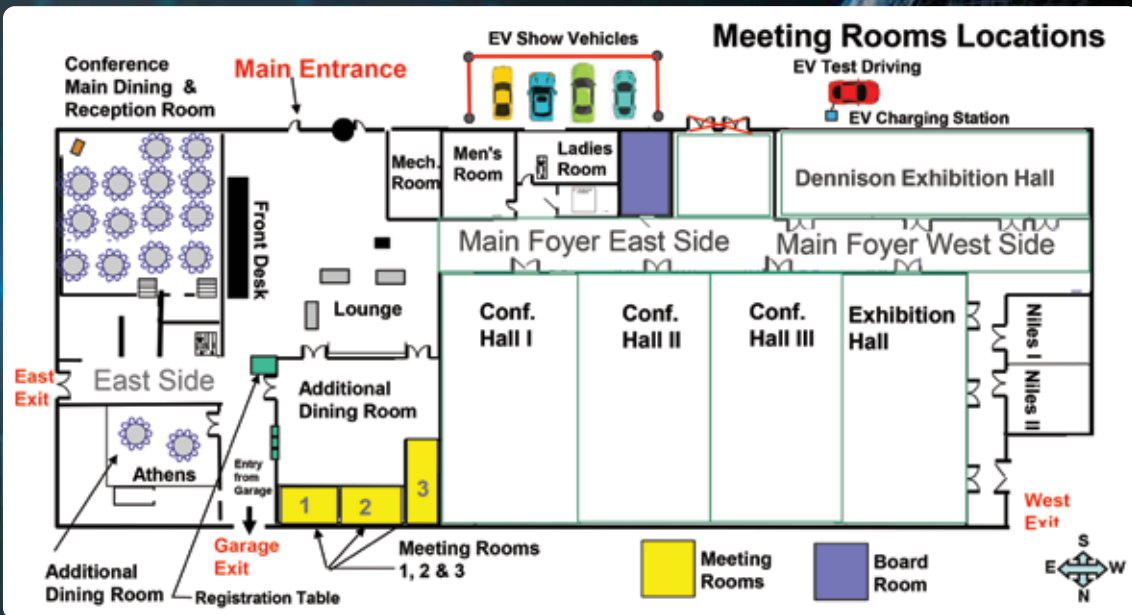
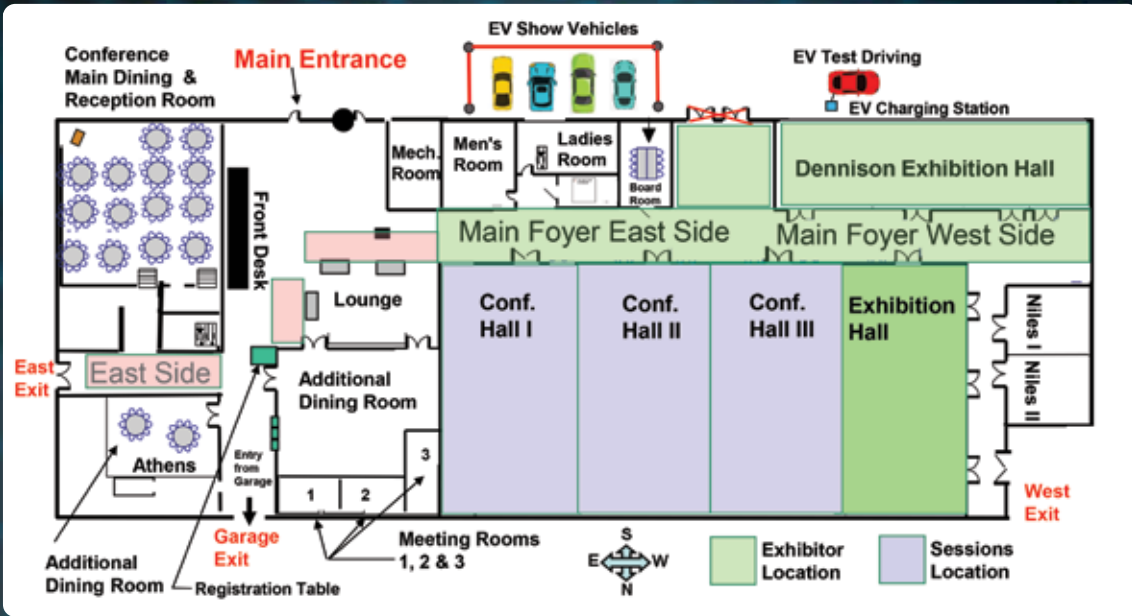

# EXHIBITORS

## EXHIBITOR LOCATIONS

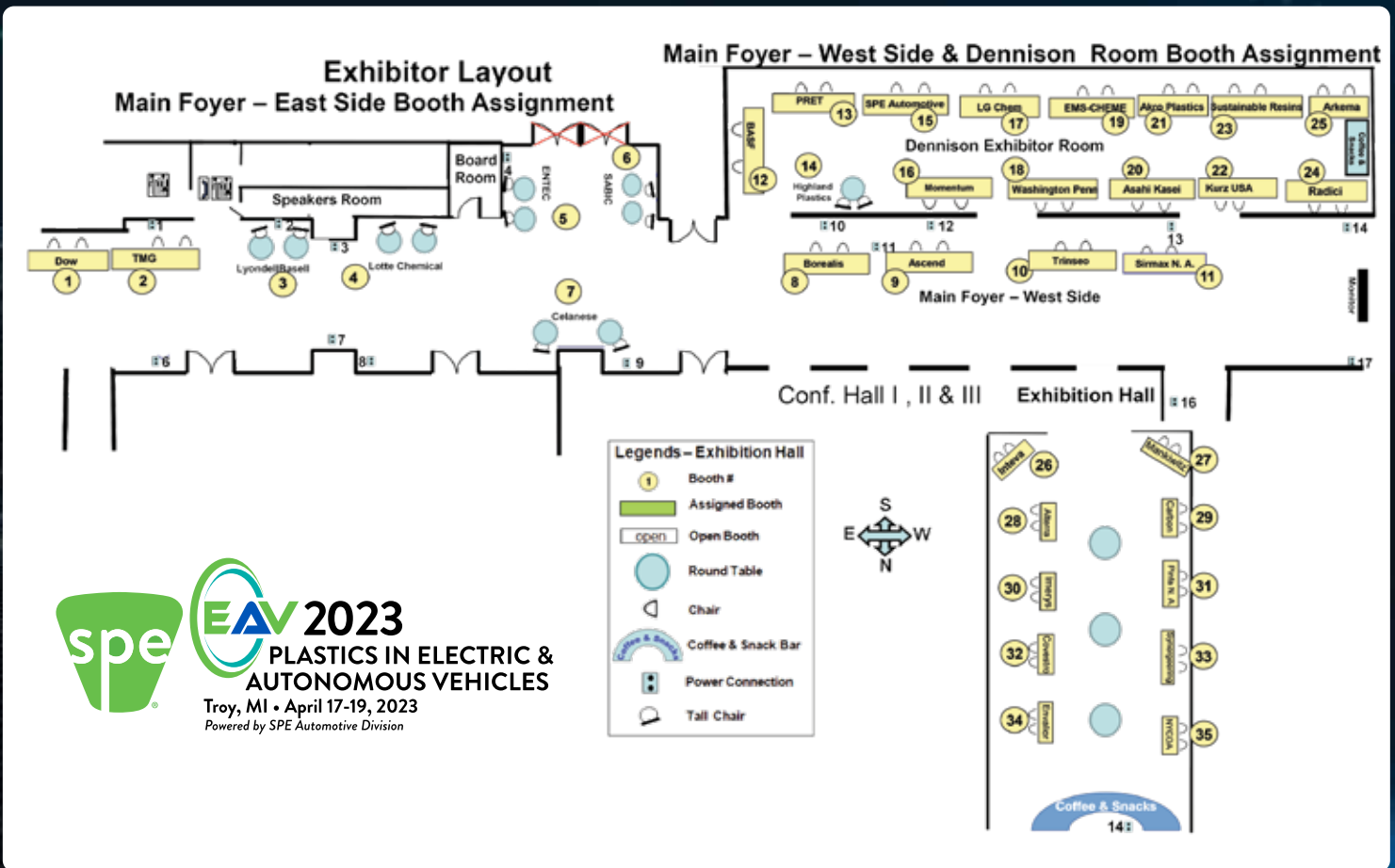

## 2023 EXHIBITORS

Akro-Plastic GMBH	Exhibitor	21	NYCOA	Exhibitor	35
Alterra	Gold	28	LG Chem America Inc.	Gold	17
Arkema	Exhibitor	25	Lotte Chemical	Platinum	4
Asahi Kasei	Exhibitor	20	LyondellBasell	Gold	3
Ascend Performance Materials	Gold	9	Mankiewicz	Gold	27
BASF	Gold	12	Momentive	Gold	16
Borealis	Gold	8	Nycoa	Exhibitor	35
Carbon Polymers	Gold	29	Pinfa N. America	Exhibitor	31
Celanese	Platinum	7	PRET	Gold	13
Covestro	Gold	32	Radici Plastics USA	Exhibitor	24
Dow / PU & Olefin	Gold	1	SABIC	Platinum + Lanyard	6
EMS-CHEMIE (North America) Inc.	Gold	19	Sirmax	Gold	11
Entec Polymers	Platinum	5	SPE	Exhibitor	15
Envalior (DSM)	Gold	34	Sustainable Resins LLC	Exhibitor	23
Highland Plastics	Gold	14	Synergeering	Exhibitor	33
Imerys	Exhibitor	30	TMG	Gold	2
Inteva Products	Gold	26	Trinseo	Gold	10
Kurz	Exhibitor	22	Washington Penn	Gold	18

# 2023 KEYNOTE SPEAKERS

## JAMIE BREWER, Executive Chief Engineer, General Motors Co.

Jamie Brewer is the Executive Chief Engineer (ECE) for electric SUVs, the Premium Import business and EV profitability at General Motors. She leads the teams responsible for all aspects of electric SUV development. Her role spans general project management, finance, design and performance. She also leads a cross-functional team focused on electric vehicle profitability. Brewer has worked at GM for more than 20 years and held several leadership roles prior to her current position, including Vehicle Chief Engineer for the Cadillac LYRIQ.

In her keynote, Brewer will share GM's EV strategy and how the company is working to create an all-electric future. Through its broad portfolio of vehicles across segments and price points, charging and infrastructure investments, and public education efforts, GM aims to put everyone in an EV. Brewer will also discuss how GM is leveraging advanced plastics technologies and manufacturing processes throughout its EV portfolio to enable its vision of a world with zero crashes, zero emissions and zero congestion.



## DEAN STEVENSON, Senior Director of Interiors, Exteriors, and Lighting

Dean Stevenson is the Senior Director for Interior, Exterior, and Lighting Engineering at Rivian. He is responsible for all aspects of design, development, and delivery from concept through product launch. His role spans product design & development, innovation, material development, tooling, and validation. He has 34 years of automotive product development experience and has held numerous leadership positions at Ford Motor Company and Tier 1 Suppliers prior to joining Rivian in 2019.

In his keynote entitled Systematizing Sustainability, Dean will talk about Rivian's approach towards driving sustainability into the product development process and how Rivian would like to lead the way in enabling implementation of sustainability through radical minimization of virgin resources and decarbonization across all stages of product design, development, production, and end of life. Dean will also discuss how Rivian is leveraging innovation in plastics development and partnerships with suppliers in delivering its mission of producing products with high sustainable content.

## JEFF MAKAREWICZ, Group Vice President – Technical Resources Toyota Motor North America - R&D

Jeff Makarewicz is the group vice president of the Technical Resources function at the Toyota Motor North America Research & Development (TMNA R&D) center based in Saline, Michigan. In this position, he oversees Business Planning & Operations, Digital Solutions, Engineering & Data Innovation, Prototype Development, Cost Planning, and Quality Promotion. Makarewicz joined TMNA R&D in 1990 as an engineer in the Materials Engineering Department and has held various leadership positions in the areas of research, design, development, evaluation, and corporate strategy. He serves on the boards of the Toyota USA Foundation and the University of Michigan Mechanical Engineering External Advisory Board. Makarewicz is a graduate of the University of Michigan.

His keynote, titled Key Challenges and Innovative Ideas to Navigate the Road to Future Mobility, discusses how the automotive industry has been accelerating toward a once-in-a-century period of profound transformation, being redefined by the disruptive CASE technologies (Connected, Automated, Shared, & Electrification). In his keynote, Makarewicz will discuss key challenges ahead and share how Toyota is developing innovative ideas to navigate the road to future mobility in their quest for "Mobility for All".



## MR. ALAN AMICI, Center for Automotive Research (CAR)

Alan Amici is the President and CEO of the Center for Automotive Research (CAR). Alan joined CAR after a 35+ year career with Chrysler and TE Connectivity, holding a variety of positions in engineering, manufacturing, and service. His roles at TE include - VP & CTO, Transportation Solutions, and VP Engineering, Automotive Americas. Highlights of his tenure at Chrysler include: Head of Global Uconnect – Infotainment and Connected Car Platform; Head of Electrical/Electronics Engineering; and Senior Manager, Global Service & Parts. Alan is the owner of two patents and is the recipient of the Walter P. Chrysler Technology Award. He holds an MBA, a Master of Science degree, and a Bachelor of Science degree in Electrical Engineering from the University of Michigan. He currently serves on the Board of Advisors at Penn State Harrisburg and the Department of Industrial Engineering at Wayne State University. He is a graduate of the Chrysler Institute of Engineering.



# 2023 KEYNOTE SPEAKERS

## ALAN AMICI (CONTINUED)

In his keynote entitled Assessment of Inflation Reduction (IRA) Act Impacts on North American Electric Vehicle Supply Chain - The Propulsion Transition Begins, Mr. Amici will discuss how the auto industry is now in the midst of a shift from internal combustion engine (ICE) to electric vehicle (EV) propulsion. This is the most significant change in the 100 year history of the automobile. Investment in EVs have been substantial in the past 2 years with more than \$35B committed to assembly and battery production in North America alone. This presentation will discuss production forecasts for ICE and EVs through 2030, EV investment landscape for North America, and the potential impact of policy such as the IRA.

## DR. KEVIN SWIFT, Senior Economist, ICIS - Global Chemicals

Dr. Swift is senior economist for global chemicals at ICIS where he is responsible for quarterly thought pieces addressing key market dynamics and is demand advisor for long-term supply demand balances. He joined ICIS after retiring as chief economist at the American Chemistry Council. Prior to joining ACC, Dr. Swift was associated with several organizations including Freedonia Group, Predicasts and Dow Chemical. Dr. Swift is a Fellow and former president of the National Association for Business Economics and a member of the Harvard Discussion Group of Industrial Economists and National Business Economics Issues Council. He is a member of The Wall Street Journal Forecasters' Survey panel and other forecast survey panels.

In his keynote note, titled Long-term Scenarios for Automotive Plastics, Dr. Swift will discuss how plastics are essential to a wide range of safety, performance, and aesthetic breakthroughs in the automotive space. Per vehicle use of plastics of 198 kgs has grown 24-fold since 1960. The long-term demand for plastics will reflect the state of the light vehicle sector and vehicle demand, on-going light-weighting trends, and electrification of mobility. The latter has important implications for plastic demand, which averaged 187 kgs. Dr. Swift will focus on three scenarios on Long Term Electrification trends and how they will impact demand by resin type and by region.

# PANEL DISCUSSION

## PANEL DISCUSSION Thermal Runaway – Scenarios and Solutions Tuesday, April 18, 2023, 10:30 AM to Noon



**TRA SCENARIOS** – Industry Challenges, Safety Concern, Possible Reasons, Battery Architecture, Trade-off between Energy Intensity, Packaging and Cost Implications

**TRA INVESTIGATIONS** – Testing & Inspection – Vehicle Level, System Level, Battery Module Level and Material Level, Standardization Gaps and Needs

**TRA SOLUTIONS** – TRA Protection – Cell Barrier, Module Separators, Enclosure with Right Use of Materials, Venting Strategies, Battery Architecture & Design

### PANELISTS



Adam Halsband  
Forward Engineering



Brian Engle  
Amphenol



Dave Sullivan  
SABIC

### MODERATORS



Dhanendra Nagwanshi  
SABIC



Dr. Jeffrey Helms  
Celanese



Maggie Baumann  
PPA / Pinfa NA



Michael Blake  
Freudenberg-NOK



Dr. James Edmonson  
IDTechEx



Eric Rask  
ITW Automotive



Ken Vessey  
UL Solutions



# 2023 SPONSORS

Our **sustainable OPTI** resins can be used all around the vehicle.

- **Opticarb™** (PC & PC Alloys)
- **Optipro™** (PP & LGPP)
- **Optilac™** (ABS & ASA)
- **Optilon™** (Nylon)
- **Optiflex™** (TPE)

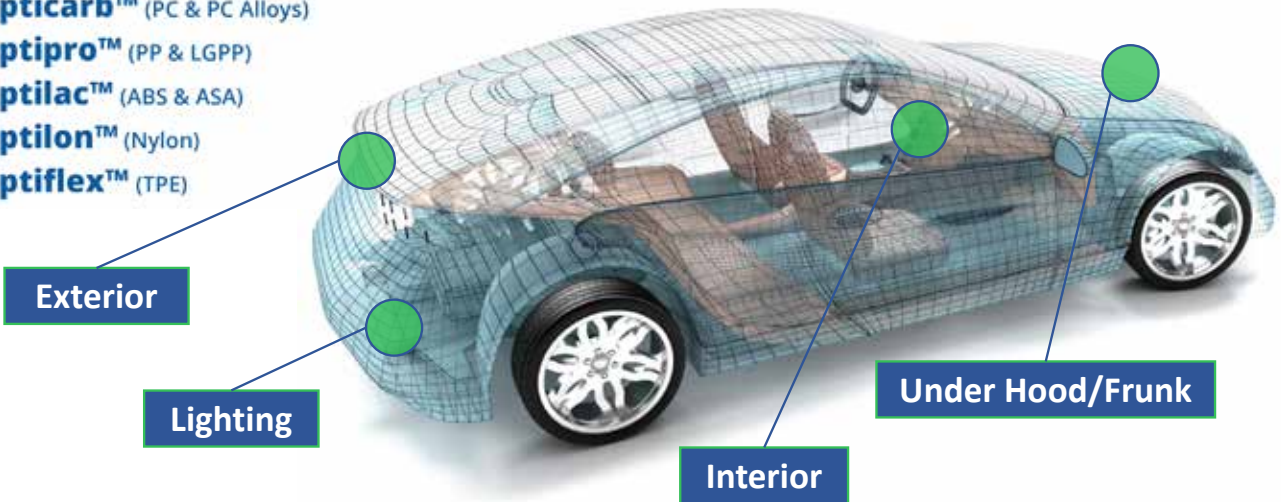

Contact The Materials Group (TMG) by email at [sales@thematerialsgroup.com](mailto:sales@thematerialsgroup.com), or for more information on the sustainable portfolio from TMG please visit [www.thematerialsgroup.com/sustainability.html](http://www.thematerialsgroup.com/sustainability.html).



## COATING SOLUTIONS FOR NEXT-LEVEL DESIGN CONCEPTS

With rapidly changing demands, automotive interiors are increasingly focusing on **ambience** and a more **lifestyle-influenced design**.

Mankiewicz offers **innovative effects** and coating solutions that allow designers to **visually** and **haptically** underline the ongoing shift into electric and autonomous mobility.



←  
Scan to  
explore  
more

Mankiewicz Coatings LLC  
1200 Charleston Regional Parkway  
Charleston SC 29492, USA

[www.mankiewicz.com](http://www.mankiewicz.com)

# 2023 SPONSORS

## BASF IS TEAMING UP TO BREAK NEW GROUND

Citroën concept car “oli” created with materials and expertise from BASF.

Learn more about how we can drive emobility innovation at [www.emobility-plastics.basf.com](http://www.emobility-plastics.basf.com)

 **BASF**  
We create chemistry

## Smart Floor Console

*With self-leveling cup holders, an articulating display and deployable HMI, Inteva's Console 360 delivers unique, lightweight and adaptable functionality to today's EV and tomorrow's autonomous vehicles.*

For more information please visit our booth.  
[www.intevaproducts.com](http://www.intevaproducts.com)

 **INTEVA**  
PRODUCTS

# BATTERY & THERMAL MANAGEMENT

SESSION CO-CHAIRS:

Dhanendra Nagwanshi, SABIC | Dr. Jeffrey Helms, Celanese Corp.  
Maggie Baumann Pinfa North America

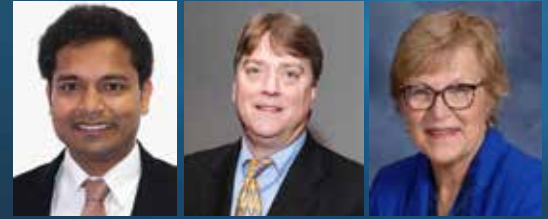

## MONDAY MORNING: 10:00 AM TO 12:00 PM



### Fire Protection Materials for EVs: Technology, Trends, and Markets

**Dr. James Edmondson,**  
IDTechEx

Fires in EVs may be a rare event. However, this does not mean that fire safety can be ignored. One key method of fire protection and an opportunity for materials suppliers is the use of passive fire protection materials. These materials are designed to limit thermal runaway propagating between battery cells and/or prolong the time it takes a fire to exit the battery pack. This presentation will draw upon research from IDTechEx's latest report on Fire Protection Materials for EV Batteries 2023-2033. The presentation will cover the drivers behind the adoption and choice of passive fire protection materials.



### Battery Enclosure Materials Screening tests Torch and Grit (TaG) and Battery Enclosure Material Screening (BEMS)

**Ken Vessey,**  
UL Solutions

Today we see the need once again in the development of electric vehicles and especially in the area of battery enclosure materials. How do we avoid a similar situation of unintended consequences when it comes to the very real-world hazard of a thermal runaway? Two new test methods will be presented that will provide everyone, from material manufacturers all the way to OEMs, the data necessary to aid in the screening, ranking, and selection of materials for use in battery enclosures. It will be shown how the scalable approach of the Torch and Grit (TaG) test to the Battery Enclosure Thermal Runaway (BETR) evaluation can provide the automotive industry the information it needs to facilitate safe performance.



### The Physics of Cell Venting Failures: Beyond UL2596 and the Need for Venting Management

**Brian Engle,**  
Amphenol

This presentation will describe the physics of lithium ion battery failures leading to cell venting and Thermal Runaway as well as the implications within large arrays and battery packs. Attendees will learn of the implications for materials used within these systems as well as the need for managing cell vent gases in a manner which reduces the risk for catastrophic failure of the system. Latest "Best Practices" in design and in the evolving challenges of dealing with damaged systems and stranded energy will be addressed as well as some of the emerging regulatory requirements for system level performance

## MONDAY AFTERNOON: 1:30 TO 3:00 PM



### Advanced insulation for High Voltage Electric Motor Winding

**Dr. Monoj Ghosh,**  
Eaton Corp.

With increase in electrification, automotive OEMs, and tier suppliers have started to adopt high voltage systems (800 Volts or even higher in future) that subsequently demand for high performance insulation with higher dielectric breakdown (DB) voltage, higher thermal endurance, increased resistance to partial discharge (PD) and higher thermal conductivity to dissipate heat and prevent overheating, and component failure. This talk will demonstrate the efforts in design & development of PEEK nanocomposite advanced insulation material, overcoming technical challenges, optimization in properties, and their benefits in high voltage e-motor winding for automotive application.

# BATTERY AND THERMAL MANAGEMENT

## SESSION CO-CHAIRS:

Dhanendra Nagwanshi, SABIC | Dr. Jeffrey Helms, Celanese Corp. | Maggie Baumann Pinfa North America



### Role of Thermoplastics in Accelerating EV Battery Pack Development

**Dave Sullivan, SABIC**

Thermoplastics, compared to metals, can offer tremendous benefits to lightweight and significantly reduce assembly complexity of an electric vehicle (EV) battery pack enclosure.

This presentation focuses on highlighting these benefits of thermoplastics while also emphasizing potential of achieving a solution with reduced environmental impact. Few case studies to demonstrate the same also presented, thus highlighting the pivotal role of thermoplastics in faster adoption of electric mobility across the globe.



### Fire Safety and the Role of FR Additives

**Maggie Baumann, Pinfa North America**

Automobile Fires have always presented a potentially life threatening hazard for the occupants of the vehicle. With the growing penetration of battery operated electric vehicles in

the market the need for new FR additives and flame retarded compounded materials is rapidly increasing. This presentation will describe the fire hazard in Electric and AV vehicles, explain how flame retardants work and what requirements in EVs and AVs are impacting the choice of fire retardants and polymer systems.



### The Growing Role of FR Additives In EVs and AVs

**Dr. Subra Narayan, Clariant**

Compared to internal combustion engines, electric vehicles pose a rather severe fire risk scenario that can result in a thermal runaway situation. Subsequently adequate protection needs to be provided to the battery as

well as peripherals using flame retardants. In this presentation, the importance of non-halogenated flame retardants for electric vehicles will be highlighted, with a focus on providing sustainable solutions.

## MONDAY AFTERNOON: 4:00 TO 5:30 PM



### Large, Safe, Lightweight, and Multifunctional Thermoplastic Enclosures for EV Battery Packs

**Fred Chang, SABIC**

Today, automotive EV and PHEV battery packs can easily reach up to 400 to 500 kilograms with a capacity of around 80 kWh. Thermoplastic materials, with

their low density and opportunity for design freedom, offer the potential to reduce weight and cost through integration and part consolidation. This presentation covers: The viability of producing large parts (complete EV battery pack covers and trays) in a variety of thermoplastic technologies for both low-volume series models (thermoforming, profile extrusion) and high-volume series models (compression molding and low pressure injection molding).



### High Energy Density Battery Pack Concept

**Pat Granowicz, Celanese**

Electric vehicle battery packs in general consist of independent modules, relying on independent an cooling system with separate structural and electrical functions all assembled to the vehicle with a non-optimal structure. Integrating

these functions will create room for more cells within a given volume for increased energy density or provide a smaller pack option with the same energy density. A novel concept integrating cooling, electrical connections and the structural frame using thermoplastic composite materials and a new chemical bonding agent is introduced.



### Polyamide Technologies Addressing Thermal Runaway Challenges in EV's

**Kai Becker, Ascend Performance Materials**

The battery with the current Lithium-Ion technology includes the enormous potential hazard of a thermal runaway that must be considered in the electrical

and structural design of the battery and the battery enclosure. In this paper, we describe an assessment of polyamide-based composites that can enable an efficient approach to lightweight battery structures and enclosures. Finally, we discuss the relevance of material properties in such a catastrophic event and how automotive could learn from other industries.

# BATTERY AND THERMAL MANAGEMENT

SESSION CO-CHAIRS:

Dhanendra Nagwanshi, SABIC | Dr. Jeffrey Helms, Celanese Corp. | Maggie Baumann Pinfa North America

WEDNESDAY MORNING: 10:00 AM TO 12:30 PM



## Trends and Disruptions for Battery Electric Vehicle (BEV) Thermal Management Systems

**Eric Rask, ITW**

This presentation begins with an overview of BEV thermal management system objectives and performance criteria. These objectives are then broken down across different circuit implementation possibilities and key BEV components. Common points of differentiation between ICE and BEV thermal systems are also highlighted to focus the discussion on specific BEV-centric requirements. Building on this foundation, a connection will then be drawn between BEV thermal systems and material performance needed for high performing systems - including key material attributes and trends for future developments.



## Temperature Management Using Thermally Conductive Electrically Insulative (TCEI) Plastic Materials

**Ray Szparagowski / Sai Sundararaman, Freudenberg - NOK Sealing**



Use of engineering plastics in electrical applications is gaining interest due to their several advantages such as reduced weight, electrical insulation, ease of manufacturing, and their ability to be tailored to meet specific design requirements. However, plastics in general are poor conductors of heat. The current work summarizes developments in engineering plastics with improved thermal conductivity while maintaining electrical insulation to better manage thermal events in electrical applications. Three case studies are presented to understand benefits of TCEI grades over commercially available materials.



## Thermally Conductive Thermoplastic Solutions for EV Battery Pack

**Soma S. Bobba, SABIC**

The cell separators ensure that there is no electrical short between the cells. The cell holder trays and cell separators available in the market today are mostly made of aluminum or steel and cannot offer the optimal solution for each of the numerous requirements. Engineering plastics can play a major role in meeting these requirements while offering light weighting, part integration and design freedom. An exercise is carried out to study the feasibility and assess performance of an injection molded thermoplastic solution for the cell holders and cell separators.



## Zytel® eCool Multilayer Coolant Tube Technology

**Nate Dumm, Celanese**

Cooling systems directly affect an EV battery's longevity and charging performance. Critical performance needs include: Flexible and reliable materials that withstand -40°C to over 150°C, and resistance to water/glycol, automatic transmission fluids, and immersion cooling/dielectric fluids. To meet performance needs and improve sustainability, DuPont has developed eCool Multilayer Technology. Based on Zytel® LCPA (Long Chain Polyamide), a tie layer, and a TPE (elastomeric) layer, this is an easy-to-extrude alternative to both PA12 thermoplastic systems and heavier EPDM rubber options.



## Santoprene® TPV in EV Cooling Hose Applications

**Paul Zwick, Celanese**

This presentation covers the development of different EV cooling hoses and tubes with Santoprene® TPV and compares to other incumbent or competitive solutions, and suggests what future needs or trends might be addressed with Santoprene® in this application.

# 2023 SPONSORS

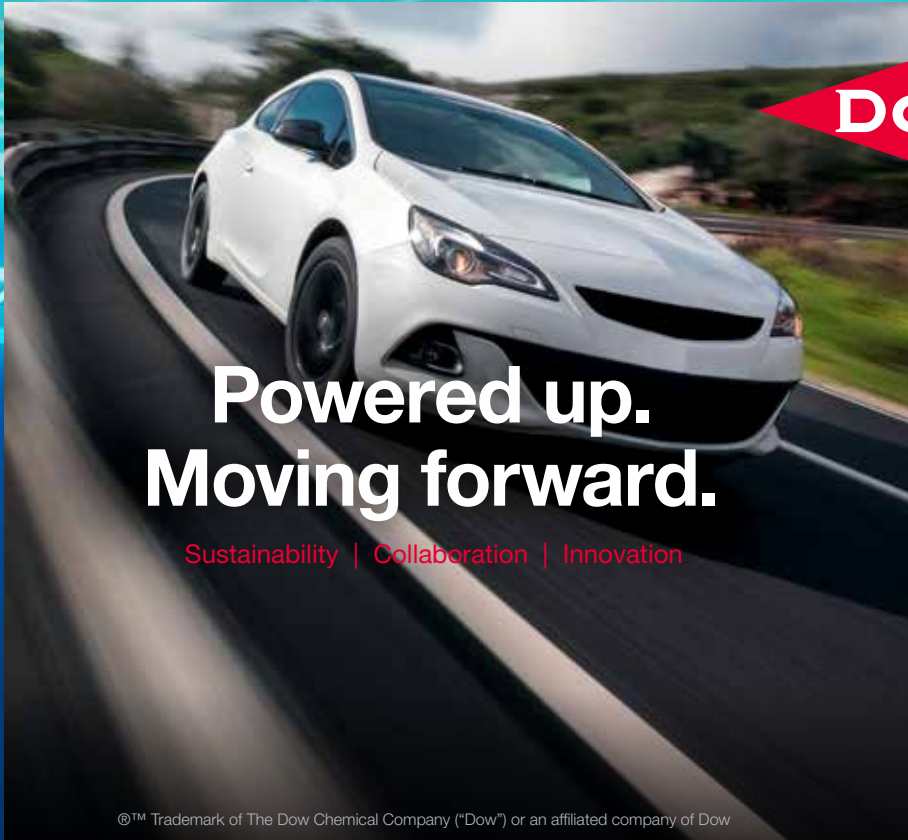

**Powered up.  
Moving forward.**

Sustainability | Collaboration | Innovation

Interior. Exterior. Powertrain. EV.  
AV. ICE. Lighter weight. High  
performance. Design flexibility. Cost  
efficiency. Processability.

Whatever your needs for advanced  
transportation materials, we're driven to help  
you keep moving forward.

MobilityScience™

®™ Trademark of The Dow Chemical Company ("Dow") or an affiliated company of Dow

WeConnectScience

LG Chem

## Future Sustainable Solution for E-mobility

How to break through climate crisis by advanced technology

Visit "lgchemon.com/s/em" or below QR code for details

Sustainability



E-mobility



LETzer

- Recycled PC, PC/ABS
- Recycled PBT
- Bio-based PA56
- Ocean Bound Plastic (PA6, PET)

# MANUFACTURING ENABLING TECHNOLOGIES

## SESSION CO-CHAIRS:

Steve VanLoozen, Lotte Chemical | David Kosse, Ascend Performance Materials



### MONDAY MORNING: 10:30 AM TO 12:00 PM



#### Innovative Hybrid Molding in Color

**Dan Rozzelman, Krauss Maffei**

Krauss Maffei, along with industry partners, has developed a work cell encompassing an Injection Molding, RIM polyurethane meter/mix and automation equipment to provide Class A Automotive interior (and exterior) parts in a 1-step process. Once the injection molded part is made, a gap in tooling is formed and that gap is flooded with PU. This technology can be used with skins, inlays, live wood and capacitive touch switches and more. Different textures and gloss finish can be realized in singular mold and a singular shot. The materials are fast drying, and some offer self-healing capabilities. The best part, they are 100% Solids (zero VOC big benefit for interior parts) for an environmentally sound solution as well.



#### HR Resistant Aliphatic Polyketone for Cooling Systems

**Daniel Baek, Akro Compounds**

Akro Plastics has developed an innovative portfolio of Aliphatic Polyketone compounds for cooling system components. These grades deliver superior hydrolysis resistance, glycol resistance, creep resistance, and heat resistance to competitive materials. In addition, these grades offer extremely good carbon footprint with a competitive cost structure.



#### Welding of FRTP for Challenging BEV Applications

**Adam Halsband, Forward Engineering**

Battery Electric Vehicles (BEV) present unique challenges for OEM and Tier Design Engineers. Amongst those challenges are the need to protect High Voltage systems from moisture ingress into Battery energy storage systems as well as the need to structurally protect components from impact and intrusion with very confined package space.

Additionally, increased mass across platforms drives the demand for advanced joining strategies for better load transfer and energy absorption.

In this presentation, the authors will provide an introduction to Vibration Welding of Thermoplastic Composites, share results from a series of plaque development trials and share insights into new thermoplastic component designs which address the new challenges outlined above.

### MONDAY AFTERNOON: 1:30 TO 3:30 PM



#### Compounding with AI

**Saeed Arabi, Alterra Plastics**

Compounding is a science. It requires a great knowledge of Chemistry, Formulation, Processing, Equipment and the Human Factor and most recently Artificial Intelligence. Compounders of today are facing many challenges that their predecessors did not face. Market fluctuation due to global issues, labor shortages as a result of pandemic, force majeure by raw material producers are few of many challenges facing compounders now. Purpose of this presentation is to show how you can "Do More with Less". Ideas to help you increase your compounding efficiency by 25% or more.



#### Optimized Compounds and Blowing Agents for Technical Applications

**Thilo Stier, Akro Compounds**

Foam injection molding is beneficial for lightweight design in technical applications with a high demand on stiffness. We have developed and tested a broad portfolio of compounds and blowing agents reducing material density more than 50%. We'll discuss innovative methodologies that prove you can produce technical applications with good surface appearance.

# MANUFACTURING ENABLING TECHNOLOGIES

SESSION CO-CHAIRS:

Steve VanLoozen, Lotte Chemical | David Kosse, Ascend Performance Materials



## Toolless Fabrication of TPU with Additive Manufacturing

**Rebecca Fecteau, BASF**  
**Steve Richardson, Forecast3D**

Additive manufacturing allows for quick turnaround and toolless fabrication. Which in turn, promotes cost effective low volume production while simultaneously avoiding the typical roadblocks of supply chain. We will be exploring this in the context of TPU which is widely known in traditional manufacturing methods, yet new to Additive manufacturing. This new material innovation is enabling interior and exterior automotive applications.



## Advanced Composites Manufacturing Solutions for the AV and EV Industry

**Anand Bora,**  
**Moldex3D**

In today's world where EV and AV are becoming progressively mainstream, we shall have batteries all over. And with those, we shall have new challenges. In this presentation,

Moldex3D shall present Advanced composite manufacturing solutions to the EV and AV industry for these challenges. We shall look at various composite manufacturing solutions that can be simulated in Moldex3D and review couple of case studies.



**KURZ** 

Join us at the KURZ booth to learn about our automotive decoration technologies!



Scan here to learn more!

# AsahiKASEI

ASAHI KASEI PLASTICS NORTH AMERICA

**Leona™**  
Nylon 66, Nylon 66 + 6i

**Xyron™**  
Modified Polyphenylene Ether

**Thermylene®**  
Chemically coupled Polypropylene

**Thermylon®**  
Nylon 6, Nylon 66

**Tenac™**  
Homopolymer & Copolymer Acetal



**Top Material Supplier for Future Mobility and Sustainability Needs**



# 2023 SPONSORS



e-range

Go farther with us

Our high-performance engineered materials include flame-retardant polyamides, long-chain polyamides and electrolyte additives all designed to improve EV safety, performance and comfort.



WE MAKE *electrification* POSSIBLE



From thermoplastic resins and compounds to thermoset composite solutions, the diverse polymer portfolio from LyondellBasell is uniquely positioned to address your **design challenges** and **sustainability goals**.

lyondellbasell  
*Advancing Possible*

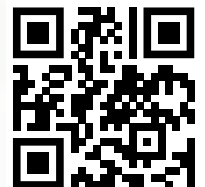

# 2023 SPONSORS

**SIRMAX**  
GROUP

## Electrifying solutions for the EV Revolution

Put your next project in the Winner's Circle with our Certified Performance Advantages!

### OUR GROUP CAN ENSURE:

- Virgin Resin Compounding with **100% Content Traceability**
- Certified Green Compounds with **100% Content Traceability**
- Captive **in-house circular polymer Production** plant
- **IATF 16949: 2016** quality certification
- **ISCC Plus certification** for recycled content

### OUR PRODUCTS FEATURE:

- **LCA Savings**
- **Flame retardant** product line
- **Metal replacement**
- **Lightweight**
- New Developments in **battery case technology**

Visit us at the EAV Show and speak with one of our Team Members about how we can supercharge your next project!

SIRMAX NORTH AMERICA  
CAMPUS IS LOCATED IN  
ANDERSON, IN  
[sirmax.com](http://sirmax.com)



**RENYCLE**<sup>®</sup>

nylon after nylon

On the road together  
towards sustainability.



Reliable, Consistent, Cost-Effective  
Commodity and Engineered Polymers  
Comprised of Recycled Content  
Since 2000

We can help you achieve your sustainability (ESG), minority sourcing, and cost-reduction goals

Pre-Consumer, Post-Consumer  
Certified Recycled Content  
Automotive Approvals  
Complex Formulations/Physical Properties  
Natural/White Color Capabilities  
R&D Support from Concept to Implementation  
Certified WBE

Contact Us  
[info@sustainableresins.com](mailto:info@sustainableresins.com)  
248-556-3470

# SUSTAINABILITY AND CARBON NEUTRALITY

## SESSION CO-CHAIRS:

Dr. Rohit Srivastava, Amazon | Drew Geda, Hyundai-Kia America



### MONDAY MORNING: 10:30 AM TO 12:00 PM



#### Carbon Footprints: The Next Driver in Evolving the Plastics Supply Chain

**Joseph Chang, ICIS Chemicals**

This presentation from ICIS will discuss key challenges that companies face in calculating greenhouse gas emissions, especially Scope 3 emissions, setting realistic targets for reductions, having a consistent methodology for primary emissions data. It will also present findings from the ICIS supplier carbon footprints tool which show wide deviation in national average climate impact for polypropylene (PP), a key polymer used extensively by the auto industry.



#### Recyclability of Polypropylene and Polyamide Composites with Basalt Fibers

**Dr. Sandeep Tamrakar, Ford Motor Company**

The recyclability of basalt fiber reinforced polypropylene (PP) and polyamide (PA6) composites were studied through injection molding and mechanical grinding. The main contributing factor for degradation in mechanical properties is attrition of basalt fibers after recycling as evidenced by fiber length distribution studies. Water absorption tests conducted at room temperature and subsequent environmental conditionings such as freeze-thaw cycling and extended freeze cycling only affected PA6 composites.



#### LG Chem Chemical Recycling Process of Polycarbonate

**BK Jeon, LG Chem**

LG Chem has been devoting to develop and commercialize a variety of sustainable products including mechanically and chemically recycled, biocircular balanced, bio-based, and biodegradable plastics. In this presentation, our chemical recycling process particularly using post-consumer polycarbonate (PC) wastes as a feedstock will be introduced. Very recently, a R&D pilot facility has been successfully built up to optimize the production process of chemically recycled PC and collect proper data package for a pre-commercial demo-plant, aimed to set up by 2026.

### MONDAY AFTERNOON: 1:30 TO 3:30 PM



#### Reclaimed Carbon Fiber Based Sustainable Solutions for Lightweight Electric Vehicle Structures

**Soma S. Bobba, SABIC**

This paper targets a weight reduction with injection molded carbon fiber filled material solutions for structures. The carbon fibers used are from postindustrial recycled (PIR) or Post-Consumer recycled (PCR) materials reclaimed from the aircraft industry. The sustainability, higher stiffness and lower weight of carbon fibers becomes the impetus for this light weighting exploration.



#### Basalt Fiber Reinforced Polyamide-6 Composites with Hemp Hurd Biochar Filler for Automotive Applications

**M. M. UI Hoque Washington State University**

Basalt fiber (BF), a naturally occurring mineral fiber, has opened new possibilities to design automotive parts as a reinforcing material in thermoplastics and be an effective substitute for glass fiber. Moreover, introducing biochar in composites can offer a sustainable, low-cost, and feasible alternative to conventional fillers in fabricating polymer-based lightweight composites with enhanced performances. The focus of the presentation will be on the results of the study investigating the processing parameters, mechanical properties, and interaction of BF-reinforced polyamide-6 composite with hemp hurd biochar as a filler.

# SUSTAINABILITY AND CARBON NEUTRALITY

## SESSION CO-CHAIRS:

Dr. Rohit Srivastava, Amazon | Drew Geda, Hyundai-Kia America



### Composite Laminates Thermoformed from Wood-Based Prepregs for Interior Automotive Applications

**Dr. Avishek Chanda, Washington State University**

The team at Composites Materials and Engineering Center of Washington State University has been involved in developing wood-strand based prepregs, analogous to synthetic fiber prepregs, that can be thermoformed for both automotive and aerospace interior applications. The aim is to substitute the currently used synthetic materials with a recyclable and sustainable option. Previous work has established the ideal parameters for fabricating wood-strand prepregs from recyclable vitrimer polymer and thermoforming them into laminates. This presentation will focus on extending the study to establish the ideal layup for achieving higher strength and stiffness values. The study will help establish the possibility of making composite laminates with large curvatures from wood-strand prepregs, which will be further extended to multi-axial bending, and eventually to other non-woven natural fiber mats.



### PCR and Bio Based TPO/TPE for Electric Vehicles

**Dr. Arash Kiani, Alterra Holdings**

Advancements in PCR material compounding with cellulose fiber provided the opportunity to develop new TPO and TPE a material with desirable properties for Electric Vehicle components. This presentation is focused on how TPO and TPE compounds with high content PCR and cellulose fiber can be used in Electric and/Autonomous Vehicles.

## WEDNESDAY MORNING: 10:00 AM TO 12:30 PM



### Evaluation of Post-Consumer Recycled Polycarbonates for Electric Micromobility Vehicles

**Dr. Rashed Islam, Lyft**

One of the Lyft Transit Bikes and Scooters' (TBS) sustainability goals is to implement post-consumer recycle (PCR) materials in all HW products. To meet the sustainability target, reliability studies were carried out to correlate the mechanical properties of PCR polycarbonates (PC) at different conditions (high temperatures, low temperatures, temperature cycling, UV, chemical etc.). In this presentation, we will show the effect of molding conditions, % PCR content, melt flow rate and various secondary processes on the mechanical properties and long-term reliability studies of PCR after different ageing conditions. Finally, we will try to answer the question "Can Recycled Plastics be used in micro mobility hardware?" Although there are many factors associated with completely answering this question, the factor which we will be evaluating in this presentation is "Strength".



### High Performance Polyamides for Demanding Battery and Thermal Management Systems

**Doug Thornhill, EMS-GRIVORY**

Today's Thermal Management System has seen significant changes of the system itself as well as types of coolants used. These increased demands have prompted EMS-GRIVORY to develop innovative materials tailor made for high temperature, high chemical exposure areas. Whether you need materials for quick connectors (QC's), flow control valves, water pumps or tubing EMS-GRIVORY has you covered with expert material selection and world class development support.

# SUSTAINABILITY AND CARBON NEUTRALITY

## SESSION CO-CHAIRS:

Dr. Rohit Srivastava, Amazon  
Drew Geda, Hyundai-Kia America



### Developments in CirculenRecover TPO Compounds with Recycled Feedstocks for Applications of Electric

**Tomik Mouradian, LyondellBasell**

Vehicles LyondellBasell has successfully developed the CirculenRecover TPO products, compounds derived from mechanical recycled materials, to combat plastic waste, protect the environment, and support the automotive OEMs sustainability efforts. This presentation will demonstrate the challenges of developing both mold-in-color (MIC) and paintable TPO materials for bumper and exterior applications as well as the novel solutions to overcome them. Strategies towards achieving on specification physical property and color consistency will be discussed. The talk will end with exhibitions of the commercial successes of a few CirculenRecover products.



### Possibilities for Reducing the Carbon Footprint

**Thilo Stier, Akro Compounds**

Design for Carbon“ or better design for lower carbon footprint. The presentation gives multiple ways to significantly reduce the carbon footprint of applications as addition to recycling route. The proven applications are showing biobased nylons, “French fries oil” based LFTs for fans with negative carbon foot print, foamed reinforced nylon with 50% less CO2



### Advancement in Sensing and Visualization Semiconductor Solutions that Enhance Safety, Comfort and Sustainability

**Michael Godwin, Osram**

By adding intelligence to light and passion to innovation we enrich people’s lives especially automotive and mobility markets. This talk will provide Osram’s vision for a sustainable future and discuss innovations that enhance safety, comfort, and user experience. Also describes how Osram is making a substantial impact with sensing, visualization, and illumination of semi-conductor components. Further exterior lighting and fully integrated smart surfaces will be highlighted with the latest optical solutions to enhance the comfort and safety.



**AKROTEK® PK-VM GF 30 FR orange (8537)**  
3D printing using pellet extrusion

**AKRO-PLASTIC GmbH**  
Member of the Feddersen Group

Im Stiefelfeld 1 • 56651 Niederzissen • Germany  
Phone: +49 2636 9742-0 • info@akro-plastic.com • akro-plastic.com



**INSPIRING PLASTICS PROFESSIONALS**

Visit the main Society of Plastics Engineers’ website for up-to-date information on training, seminars, and other career-enhancing information.

**BECOME A MEMBER TODAY**  
<http://www.4spe.org/membership/>



# 2023 SPONSORS

**MOMENTIVE**  
SOLUTIONS FOR A SUSTAINABLE WORLD

## SiIFORT™ HARDCOATS

Enabling Plastics.  
Enabling Innovation.

- Weatherability
- Scratch Resistance
- Chemical Resistance
- High Gloss
- Design Flexibility
- Light Weight



## EMS-GRIVORY

Your Partner for Thermal Management  
in Electric Vehicles



Tailor-made products for cooling  
and heating systems



Efficient thermal management  
for maximal performance  
and range



Grivity  
HT1VA

Grilamid  
L 25 A NZ

Grivity  
HT1VA



Revolutionize the thermal management of electric vehicles with EMS-GRIVORY and the innovative high-performance materials Grivity HT1VA (PPA), Grilamid L and D (PA12, PA612). Grivity HT1VA provides unsurpassed hydrolysis resistance to cooling media as well as very high dimensional stability. Grilamid L and

D offer flexibility, very good chemical resistance, easy connections and an efficient extrusion process for smooth and corrugated pipes. Choose EMS-GRIVORY as experienced and recognized development partner for demanding, durable and at the same time economical cooling components in electric vehicles.

### Your Innovative Development Partner

EMS-GRIVORY North America  
3201 University Dr. | Auburn Hills, MI 48326  
[www.emsgrivory.com](http://www.emsgrivory.com)





## AUTO EPCON 2023 CONFERENCE | MAY 2, 2023

Detroit Marriott - Troy Hotel, 200 Big Beaver Rd, Troy, MI 48084

### KEYNOTE SPEAKERS

*Ankil Shah, Toyota Motor North America*

*Joe Langley, S&P Global*

*Sandry Munro, Munro & Associates*

### CALL FOR STUDENT POSTERS

**POSTER ABSTRACT SUBMISSION DEADLINE: APRIL 10, 2023**

**ACCEPTED STUDENT PRESENTERS NOTIFIED: APRIL 17, 2023**

- > Students must bring their posters printed on the template provided.
- > For queries regarding the poster session, please email:  
Dr. Brian Knouff: [knouffbj@ornl.gov](mailto:knouffbj@ornl.gov)  
Dr. Mahmood Haq: [haqmahmo@egr.msu.edu](mailto:haqmahmo@egr.msu.edu)
- > For queries regarding travel assistance, please email:  
David Okonski: [david.a.okonski@gm.com](mailto:david.a.okonski@gm.com)

### SPONSORSHIP OPPORTUNITIES & CONFERENCE REGISTRATION

For sponsorship and registration information please use this link  
<https://www.4spe.org/i4a/pages/index.cfm?pageid=8018>

# ADVANCED DRIVER ASSISTANCE SYSTEMS

SESSION CO-CHAIRS:  
Dr. Rodrigo Orozco, Celanese | JP Wiese, SABIC



MONDAY AFTERNOON: 4:00 PM TO 5:30 PM



## SABIC Specialties' Solutions for Automotive Radar Sensors

Dr. Jeff Xu, SABIC

This presentation highlights solutions offered by SABIC's Specialties business regarding engineering plastics used in automotive radar sensors. Specifically, certain engineering design considerations should be taken when selecting materials for the radome, back cover, and internal parts in order to improve the radar performance. Key topics will include material considerations for radar transparency & low warp for use in radomes, radar absorption, thermal management and EMI shielding.



## Material, Process and Design Effects on Warpage in Camera Brackets

Brandon Bouchard, Celanese

Design, material, and processing all play a role in warpage, there is a need to better understand their influence in camera brackets. Using a custom design, a mold insert was

made allowing for the direct evaluation of warp. This custom part was designed with similar features to current brackets for better comparisons. With the insert, different materials from Celanese's portfolio were used for comparison based on resin and processing conditions. An updated design is also used for evaluation to establish the potential improvements from design. Results show that warpage can be improved with the use of lower warp material and processing with recommended conditions. Recommendations based on these results will assist in solving the challenges with ADAS bracket design.



## Optimizing Radar Performance of Exterior Trim

Carlos Pereira, SABIC

This paper discusses design and new material possibilities for exterior trim parts, with the aim of minimizing RADAR reflections by increasing the transparency of trim parts, improving performance to the 76-81 GHz frequency range. It details the effect of coatings, additives (mineral reinforcements and pigments) and mechanically recycled content on RADAR transparency based on their measured dielectric behavior. It also explores the use of measured properties in predictive engineering to optimize both the composition of materials and the geometry of the trim.



**spe** AUTOMOTIVE  
**PLASTICS NEWS**

A PUBLICATION OF THE AUTOMOTIVE DIVISION OF THE SOCIETY OF PLASTICS ENGINEERS

Looking for a cost-effective way to  
**REACH TRANSPORTATION ENGINEERS** working with plastics around the world?

Help sponsor our **SPE AUTOMOTIVE DIVISION NEWSLETTER**,  
distributed globally three times per year. [speautomotive.com/news](http://speautomotive.com/news)

For rates & information, please contact Teri Chouinard at Intuit Group, [teri@intuitgroup.com](mailto:teri@intuitgroup.com) +1.248.701.8003



# 2023 SPONSORS

**Innovative Solutions**  
**Trusted Expertise**  
**AI Compounding**



We have been at the forefront of the plastic compounding for more than two decades. 9 production lines and state of the art AI Technology.

We produce high quality Elastomers , Filled PP, TPO and Bioplastics.

Our PCR/PIR, Marine Degradable and Cellulose Fiber products reflects on our commitment to the environment. Alterra is your source for Innovative Compounds or Toll Compounding Services.

ISO 9001:2015  
ISO 17025:2017  
Member of OCS (Operation Clean Sweep)  
Third Party GMP Certified

2213 Killion Ave Seymour, IN 47274  
+1 (812) 271-1891  
customerservice@compounding.us

A large advertisement for Trinseo. The background is a vibrant, multi-colored abstract pattern of lines. On the left, there is a stylized graphic of a hand holding a colorful, multi-colored ribbon. The main text is in large, bold, yellow and white letters. The Trinseo logo is in the top right corner, and a QR code is in the bottom right corner.

**Learn how  
we drive  
innovation  
farther.**

**TRINSEO**  
Connecting ideas with solutions

# 2023 SPONSORS



**CRAFTING  
CONNECTIONS  
WITH YOU.**

**SAFER  
LIGHTER  
MORE SUSTAINABLE**

We help you reach your safety, lightweighting and sustainability goals by investing in existing and new applications across the value chain.

DSM Engineering Materials is now Envalior.  
[www.entalior.com](http://www.entalior.com)



# EVOLUTION OF EXTERIORS & LIGHTING

SESSION CO-CHAIRS:

Volker Plehn, SABIC | Tom Pickett, General Motors  
Mark Lapain, Advanced Composites

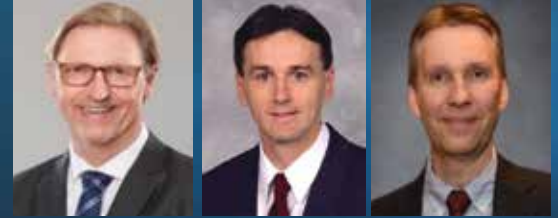

## MONDAY AFTERNOON: 4:00 PM TO 5:30 PM



### Material Solutions and Innovations for Exterior Panels

**Volker Plehn, SABIC**

Material solutions and Innovations for Smart Panel that will cover: (1) Design trends for Electrification and Autonomous Driving; (2) The integration of Lighting and Sensors in Exterior Panels; (3) Material solutions for Functional Integration, Lightweighting and Aesthetics



### Smart Rear & Front Panels by Purposefully Combined Plastic Processing

**Michael Fischer, Engel**

Insights into newest machine development, with the purpose of productivity and sustainability improvements. The focus will be on functional integration; 1 component & 2 component injection molding combined with IMD & Insert molding, and PUR overmolding purposefully integrated into the molding process.



### Innovative Protective Coatings for Automotive Exterior Parts, Headlamps and Sensor Covers

**Dr. Andreas Haeuseler, Momentive**

Momentive's protective coatings enable the use of plastics in demanding automotive exterior applications by offering excellent scratch, abrasion and weathering resistance, while maintaining high optical clarity. Premium front-end-modules for EVs offer unique design possibilities with the integration of decorative lighting and integration of ADAS sensors. Emerging technologies will also be presented, including durable, easy-to-clean coatings and protective coatings with improved sustainability benefits.

## TUESDAY AFTERNOON: 1:30 PM TO 3:30 PM



### The Development of Integrated Multifunction EV Grille

**George Liu, Minth**

Industry trends for front panels include integrated sensors, illumination for distinct styling and interaction with the environment. We will present a systematic way to develop an EV multifunction front panel. Based on material dielectric properties, material will be selected and wall thickness at radar zone will be defined properly. To control the warpage and dimension, pre-deformation and injection compression process are implemented. Laser source selection and parameter optimization for laser ablation helps achieve variable styling and meet performance requirements for exterior components.



### Innovative Designs and Environmental Solutions to Meet Customer Demands

**Brian Guinn, Valeo**

Automotive lighting is the middle of a major transition to become fully integrated with the vehicle functions while simultaneously supporting environmental considerations in plastic material selection and design. This presentation covers the changing automotive lighting technology and how plastic materials, with consideration for environmental and CO2 reduction, can be integrated to meet these changing requirements.



### Material Solutions that Enable Cost and Weight Savings in Automotive Exterior

**Dan Fuller, Celanese**

Engineered material technologies such as thermally conductive plastics, Liquid Crystal Polymers and reflective white Polypropylene compounds can expand the design envelope of EV Exterior Lighting through part consolidation, managing thermal challenges and reduce part weight through metal to plastic conversion while delivering low-cost alternatives.

# EVOLUTION OF EXTERIORS & LIGHTING

SESSION CO-CHAIRS:

Volker Plehn, SABIC | Tom Pickett, General Motors  
Mark Lapain, Advanced Composites



## Managing Heat Using Thermally Conductive Polycarbonates to Achieve Weight, Space and Cost

**Jim Lorenzo, Covestro**

Thermal management of battery systems is critical for both operating efficiency and safety. Maintaining the temperature range preferred by battery cells is key to obtaining best operating results and longest life. We will show how thermally conductive polycarbonates can help reduce steady state operating temps and contribute to improved pack performance.



The Phosphorus, Inorganic & Nitrogen Flame Retardants Association is Committed to Fire Safety and Improving Human Health & the Environment

## Enabling Fire Safety for Automotive Plastic Materials



Pinfa-NA is a proud sponsor of:

## Plastics in Electric & Autonomous Vehicle Conference, 2023

Visit our website at [www.pinfa-na.org](http://www.pinfa-na.org) for more information.

# ARKEMA

Advanced Bio-Circular Materials for busbars, cooling lines, and more!



Learn why Advanced Bio-Circular matters at Booth 25!



Synergeering Group, LLC is a full service provider for large, fully-functional, **RapidNylon**® prototypes and low-volume production parts. With four state-of-the-art laser sintering machines, each with the world's largest practical build chamber, we produce industry leading quality parts with an unrivaled delivery time. Synergeering can take you from CAD to testing, or skip the tool, in just days!

Work with Us!

Email us at [project@synergeering.com](mailto:project@synergeering.com)  
[www.synergeering.com](http://www.synergeering.com)



# EVOLUTION OF INTERIORS

SESSION CO-CHAIRS:

Dr. Rose Ryntz, Ryntz & Assoc., LLC | Jeff B. Crist, Ford Motor Co.  
Jim Keller, Mankiewicz Coatings LLC



## TUESDAY AFTERNOON: 1:30 PM TO 3:30 PM



### Dual Cast Process for Designing Circular and Monomaterial for Automove Interiors

**Dr. Murali Reddy,**  
CpK Interior Systems

CpK has developed a new method of manufacturing an automotive interior trim panel i.e. dual cast process which enables to produce both skin and foam in a sequential way. This process uses same base resin to produce both skin and foam and improves the recyclability significantly while reducing the scrap rates to less than 5%. In this presentation, dual cast process will be discussed using PVC and TPO chemistries and how circularity and materials are achieved for automotive interior trim applications.

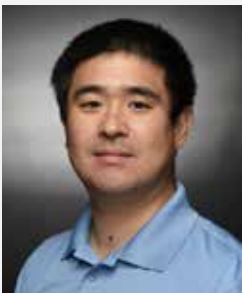

### Translucent Foam: Physical Properties and Level of Light Transmittance

**Kiego Shimura, Sekisui Voltek**

With the rising demand for more illuminated surfaces in the automotive interior, the development of light-transmissive foam and the properties that affect the level of light transmission through foam was studied. It was discovered that the foam color and the cell size have a large impact on the level of light transmittance. In this presentation, the development of Sekisui Chemical's crosslinked closed-cell translucent polyolefin foam and the properties that influences it will be discussed.



### Advances in Automotive Interiors

**Dr. Pravin Sitaram,**  
The Haartz Corporation

With the advent of Electric vehicles, the interior space is transforming. The conceptualization of automotive interiors has challenged foil manufacturers to align with the changing needs and requirements. This presentation will provide an insight into the different surface material options the Haartz Corporation has to offer for applications within the interior space of an automobile.



### Needs, Challenges and Film-Based Solutions for Functional Decoparts

**Paul Rye, Kurz**

With the continued evolution of decorative interior surfaces into functional touch surfaces, KURZ will outline the technical challenges presented to traditional film materials and part processing methods. KURZ will showcase new ideas that evolve current part processing techniques and offer unique solutions for backlighting, touch integration and anti-microbial performance into molded part applications.

## TUESDAY AFTERNOON: 4:00 PM TO 6:00 PM



### Throwing Your Shoes at Your Car Seat

**Aaron Delong, HP**

Discover how lattice research and design are being leveraged to customize the seating experience. Learn how programable design allows us to create complex structures in hours. See how correlation to FEA models is achieved and leveraged to quickly iterate a design that achieves a targeted curve in foam replacement.



### Mineral-Based Solutions for EAV Plastics and Sustainability

**Dr. Saied Kochesfahani**  
IMERYS Performance Minerals

This presentation will introduce Imerys portfolio of minerals for automotive plastics focusing on the needs of electric vehicles. ImerShield is a new line of flame retardant (FR) synergists developed for intumescent FR engineering thermoplastics, and is expanding into other FR plastics of interest to EV. Mineral based solutions will also be introduced for maximizing stiffness and dimensional stability, minimizing anisotropy, warpage and weldline effect, promoting light-weighting, and reducing carbon footprints.

# EVOLUTION OF INTERIORS

SESSION CO-CHAIRS:

Dr. Rose Ryntz, Ryntz & Assoc., LLC | Jeff B. Crist, Ford Motor Co. | Jim Keller, Mankiewicz Coatings LLC



## Automotive Acoustic Materials: Design for Sustainability

Jian Pan, Auria Solutions

The automotive industry is embracing green technologies and initiatives that drive new product development in the supply chain. Acoustic materials play an important role in vehicle noise control. This presentation will discuss various aspects of sustainable design of automotive acoustic components while maintaining or improving acoustic functions.



## Electrification Driven Challenges for Automotive Plastics

Bernd Henkelmann  
Radici Group

The electrification of automobiles has significant impact on the selection of polymers used in cars. Higher voltages in EV require flame retardant polymers and special colors like "safety-orange" as a warning indicator. The presentation will show the different FR-technologies as well as heatstable orange materials to meet these requirements. It will also show solutions to avoid contact corrosion in electrical components.

## Sustainability with Carbon Polymers PCR/PIR Products



At Carbon Polymers, we are dedicated to **sustainability** and reducing plastic waste in the **environment**. Our advanced compounding process allows us to transform a wide range of polypropylene feedstocks from **post-consumer and pre-consumer sources** into **high-quality, usable products**. Join us in the fight against plastic pollution and learn more about our **cutting-edge** recycling process.

- Certified Post Consumer and Pre-Consumer feedstocks used to produce Automotive Approved Polypropylenes, TPO's, and TPE's.
- Designers of materials with certified Recycle and Reuse feedstreams to focus on "Landfill Avoidance" initiatives and to meet Recycled Content mandates that turn plastic waste streams designed for the landfill into high quality certified materials used in automotive, construction, health care, transportation, furniture, consumer goods application.

104 Lee Street,  
Lodi OH 44254 (330) 948-3007

1100 N Johnson Rd  
Sebring, OH 44672 info@carbonpolymersco.com

# MATERIAL INNOVATIONS

SESSION CO-CHAIRS:

Michael Shoemaker, Borealis | Paula Kruger, Ascend Performance Materials  
Sunit Shah, LyondellBasell



## TUESDAY AFTERNOON: 1:30 PM TO 3:30 PM



### Advanced Polymers for Electric and Autonomous Vehicles Applications

**Dr. Sassan Tarahomi, Altera Holdings**

This plenary talk discusses advanced polymer material applications for these vehicles. Vehicle Structure, Drivetrain including Battery, Interior and Safety Systems are focus of this presentation.



### Novel Formulating Strategies for Flame Retardant Automotive Compounds

**Jakub Lison, ICL Industrial Products**

In this presentation, we will cover the prognosis for the NEV market and the related infrastructure. We will discuss the variety of flame retardant choices that exist in the market, and the outlook on regulatory issues surrounding them. We will cover how additive choices affect sustainability of plastics and properties such carbon footprint. We will share the new formulating approaches for pertinent applications such as connectors, battery enclosures and other areas of modern EV.



### Enabling Thermal Management with Innovations in Thermally Conductive Plastics

**Dr. Prabuddha Bansal, Celanese**

Polymers or, by their nature, plastics, are inherent thermal insulators. However, recent developments have enabled injection-molding grade plastics to have thermal conductivities more than 100 times the conductivity of the base resin. These thermally conductive plastics are composite materials consisting of high thermal-conductivity reinforcements in engineering and commodity thermoplastics.



### High Performance Polymers for Busbars in Power Electronics and e-Motors of Electric Vehicles

**Dr. Victoria Lee, Solvay**

A variety of busbars are used in various sub-systems within an electric vehicle, such as e-motor, power electronics and batteries.

Each of these applications demands a specific set of material performances in terms of electrical insulation, thermal shock resistance, thermal runaway protection, chemical resistance, structural integrity and mechanical performance. With these requirements in mind, Solvay Materials has developed a new family of PPA (semi-aromatic polyamide) products which are partially biosourced and also produced using 100% renewable electricity.

## TUESDAY AFTERNOON: 4:00 PM TO 6:00 PM



### Next-Gen Automotive Materials to Increase Safety and Reliability in the Electrical Powertrain

**Keith Kauffmann, DSM**

In this presentation, we will present the latest in polymer material developments that will provide an increase in performance for the age of electrical mobility.



### Next Generation Polyurethane for Internal Battery Structure

**Chris Korson, BASF**

BASF have recently launched several new high-strength continuous fiber pultrusion applications using the BASF Elastocoat® Polyurethane. These composite solutions are replacing traditional high strength metal solutions due to the superior strength to weight ratio, new assembly advantages, and an improved value proposition.

# MATERIAL INNOVATIONS

SESSION CO-CHAIRS:

Michael Shoemaker, Borealis | vv Kruger, Ascend Performance Materials | Sunit Shah, LyondellBasell



## Bonding to Dielectric Materials in Battery Pack Assembly

**Dr. Thomas Clark,  
DuPont**

Thermal interface materials and adhesives in particular must provide reliable chemical and physical bonding to the surfaces of high dielectric materials with minimal pretreatment to increase longevity of the battery packs. An overview of the challenges of bonding to high dielectric materials and case studies of adhesives in battery case assembly will be provided



## Conductive Molding Compounds in Fuel Cell and Battery Applications

**Mike Kiesel,  
LyondellBasell**

As the global fuel cell, flow battery and hydrogen electrolyzer markets continue to grow, conductive thermoset molding compounds will play an important role in bipolar plate applications used in these technologies. In this presentation, we will explore how the material is made, processed into bipolar plates and compared to other commercial materials.

**Taking Plastics & Rubber to the next level**  
with functional minerals that enhance performance

marketingna@imerys.com  
www.imerys.com

NYLON CORPORATION OF AMERICA

**NYCO6** (Nylon 6)  
**NYCO66** (Nylon 66)  
**NXTamid T** (Nylon 610, 612)  
**NXTamid L** (PA11 and PA12 alternative)

Contact Ranvir Soni, Director of Business Development  
248-787-1097 | rsoni@nycoa.com

**ONE TINY PELLET  
Millions of Possibilities**

Made In Manchester, NH  
nycoa.com





# AUTOMOTIVE GOLF OUTING

Fieldstone Golf Club • Auburn Hills, MI  
Presented by SPE Automotive Division

SEPTEMBER 5, 2023

## 28<sup>TH</sup> ANNUAL SPE GOLF OUTING

PROCEEDS BENEFIT SPE STUDENT CHAPTERS

### 2023 SPONSORSHIP OPPORTUNITIES

TYPE OF SPONSORSHIP	COST	BENEFITS INCLUDE
CONTEST HOLE	\$1000. USD	1 foursome, signage, flag & more
HOLE	\$750. USD	1 foursome & signage
BREAKFAST	\$1500. USD	2 foursomes & signage
LUNCH	\$2000. USD	2 foursomes, signage & 100 fliers printed & distributed at the event promoting sponsoring company or its products
DINNER	\$3000. USD	3 foursomes, signage, company message / logo on dinner table centerpieces, 100 fliers printed & distributed at the event promoting sponsoring company or its products

Please note that Team Captains are asked to bring donations for the Prize Table.

#### SPONSORSHIP CHAIR:

Teri Chouinard, Intuit Group  
+1.248.701.8003  
teri@intuitgroup.com

<https://speautomotive.com/spe-golf-outing/>

# SEPT 5 2023

#### COST:

\$500. USD/Foursome  
\$125. USD/Player

#### PROGRAM:

8:30am: Sign-in & Continental Breakfast

10:00am: Shotgun Start

Box Lunch at Turn

3:30pm: Buffet Dinner

4:00pm: Awards & Prizes



FIELDSTONE GOLF CLUB  
1984 Taylor Road Auburn Hills, MI



**AUTOMOTIVE COMPOSITES  
CONFERENCE & EXHIBITION**  
Novi, MI • September 6-8, 2023  
*Presented by SPE Automotive and Composites Divisions*

**COMPOSITES THE KEY TO EV**  
AUTO & AIR MOBILITY

WORLD'S LEADING AUTOMOTIVE  
COMPOSITES FORUM



## CALL FOR PAPERS

## SPONSORSHIP OPPORTUNITIES

The automotive and transportation industries are advancing with composites playing a key role in the development of electric vehicles, air mobility, and sustainability initiatives worldwide. Lightweight composites are ideal materials for improving vehicle performance, reducing mass, extending range and compensating for battery weight. Polymer composites are enabling lower emission vehicles, reducing the carbon footprint and saving energy to benefit the environment now and in the future. Thermoset and thermoplastic composites are **THE KEY TO EV**  
AUTO & AIR MOBILITY

For more information and to register, go to:  
<https://speautomotive.com/acce-conference/>

The presentations are organized into the following categories: Composites in Electric Vehicles, Thermoplastic Composites; Thermoset Composites; Modeling; Additive Manufacturing & 3D Printing; Enabling Technologies; Sustainable Composites; Bonding, Joining & Finishing; Carbon Composites; and Business Trends/Technology Solutions. Paper abstracts are due **ASAP**. Final scientific papers or non-commercial presentations are due by **May 31, 2023**. Authors who submit papers (not presentations) in the proper format will be considered for the conference's Best Paper Awards, which are presented during the event's opening ceremony. A template for papers can be downloaded from the SPE ACCE website online via <http://speautomotive.com/acce-forms>. Abstracts and papers or presentations must be submitted online via the **SUBMIT 2023 ABSTRACTS/PAPERS OR PRESENTATIONS HERE** button on <https://speautomotive.com/acce-conference/>.

**SPONSORSHIP AND EXHIBIT OPTIONS** offer companies the opportunity to support the event and promote their products and services to a very targeted and interested audience. All sponsorships include passes to the event including access to all keynotes, panel discussions, technical sessions and daily networking opportunities. Sponsorship also includes corporate exposure on SPE ACCE websites, advertising, publicity, social media, signage throughout the event venue and more. Companies interested in sponsorship should contact Teri Chouinard at [teri@intuitgroup.com](mailto:teri@intuitgroup.com).

### THANK YOU TO OUR 2022 SPONSORS

FEATURED SPONSOR  
& EXHIBITOR



PREMIER PLUS SPONSORS & EXHIBITORS

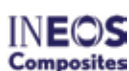

+ RECEPTION SPONSOR



STUDENT POSTER  
COMPETITION SPONSOR

LUNCH SPONSORS



PREMIER SPONSORS & EXHIBITORS



ASSOCIATE SPONSORS & EXHIBITORS



TABLE TOP SPONSORS & EXHIBITORS



ADVERTISING SPONSOR



MEDIA / ASSOCIATION SPONSORS



# NOISE AND VIBRATION

SESSION CO-CHAIRS:

Andrea Frey, General Motors | Dr. Xian Jiang, Dow

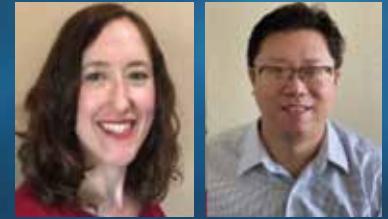

## TUESDAY AFTERNOON: 4:00 PM TO 6:00 PM



### Automotive Acoustic Materials: Design for Acoustics & Applications in Electric Vehicles

Jian Pan, Auria Solutions

New electric vehicle architectures and e-components present unique challenges and opportunities for acoustic materials selection and design. This presentation will discuss acoustic materials properties, characteristics, and design considerations to address noise issues that are unique to electric vehicles.



### Absorption and Reflective Properties of a Crosslinked Foam

Keigo Shimura, Sekisui Voltek

Sound is a form of energy that transmits through the air as pressure waves. When it hits a surface, it can either be absorbed, reflected, or transmitted. Sekisui Voltek manufactures foams that are used for vibration dampening with acoustical benefits. This presentation will feature products that have absorption characteristics and reflective characteristics.



### Anti-Vibration Polyamide Solutions to Overcome a Multitude of NVH Challenges

Jason Park, Ascend Performance Materials

Thermoplastics are cost effective, corrosion resistant, and light weight alternatives to metallic materials. Polyamides are a class of thermoplastics with high toughness which are suitable for structural components under severe load conditions. A series of novel thermoplastic materials are being developed by polymer backbone alteration to target NVH issues at several environmental and operating conditions. Background data of these material solutions will be presented and linked to specific application spaces. In addition, applicable tool based on a predictive model, correlated with real-life, will be provided to utilize in component design for NVH.

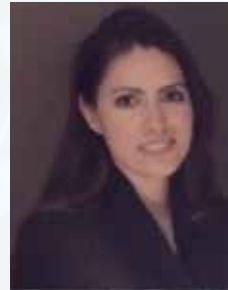

### Design for Sustainable Solutions and Carbon Neutrality

Karen Guzman, Covestro

Circularity demands new technologies, designs, material choices and their efficient use in saving precious resources, while reducing the long-term impact of CO<sub>2</sub> emissions. This presentation will provide an overview of the latest sustainable Polycarbonate solutions from Covestro, specific examples of the design for sustainability and other sustainable approaches and raise key challenges requiring collaboration across the value chain to realize a more sustainable automotive vehicle production.

## WEDNESDAY: 10:00 AM TO 12:30 PM



### Sustainable Composites for Lighter and Flame-Retardant Electric Vehicle Parts: Challenges on Thermal Management and Enclosures for EV Batteries

Prof. Amar K. Mohanty, Univ. of Guelph, Canada

Sustainable composites are defined as composites from bio-resource, recycled as well as waste materials including their hybrids. In addition, the inclusion of sustainable flame-retardants over halogenated ones in the EV components will increase the flash over duration, resulting in better thermal management and delay in thermal runaway. This presentation will highlight the current challenges, existing solutions, and emerging opportunities by adopting advanced high performance sustainable composite technologies for EV components. This will also address the criteria for materials' circularity towards climate benefits.

# NOISE AND VIBRATION

SESSION CO-CHAIRS:

Andrea Frey, General Motors | Dr. Xian Jiang, Dow



## Development of a Multi-Layer Acoustic Package Model for Automotive Acoustics

**Manoj Thota,  
Dow**

The drive for electrification and lighter materials is a significant factor in current research on materials for automotive acoustics. To advance the development of new materials, this study created an acoustic model of a multi-layer acoustic package using commercially available SEA software. Properties of bulk and porous materials in various layers was collected to build the model, and testing was done on a multi-layer package in a flat panel configuration to validate it. The validated model will be used to create new materials and structures.



## Frunk Made of Ultra-Silent: Greater Driving Range for Electric Cars

**Michael Collinsworth,  
Autoneum NA**

With demand for electric cars growing sharply, the need for lightweight components that enable a greater driving range for this category of vehicles is rising as well. Autoneum now offers a front trunk made of Ultra-Silent – the lightweight, noise-reducing and sustainable technology bestseller for underbodies – particularly developed for electric vehicles. Autoneum's lightweight innovation is already in pre-development for a model of a new electric vehicle manufacturer and available in Europe, North America and China.



## How Composite e-Motor Mounts Affect EV NVH

**Ricardo Mercado,  
BASF**

BASF has led the Automotive Industry in developing composite powertrain and suspension mounts replacing die cast aluminum and stamped steel mounts. This has been done by in traditional Internal Combustion Engine (ICE) vehicles by demonstrating similar or better NVH performance at a lower mass and typically at a lower cost. Is this true for e-Motors where the noise spectra for different types of noise sources varies in comparison to ICE powertrains? BASF will review a recently completed study which an aluminum die cast e-Motor mount was compared to composite motor mount on a serial production EV and describe the value proposition it offers to the EV industry.



## 2nd Generation NVH Zytel™ Hushes the Crowd with Muscle

**Gabriel Knee,  
Celanese**

Auto electrification creates new standards for NVH performance and polymers are a key component to success. First generation NVH materials accomplished this goal with sacrifices, new second generation materials build on NVH characteristics while eliminating structural strength sacrifices that were required before. Learn how this new generation of NVH material extends life and will propel future polymer design allowing for greater use of polymer composites in future vehicles.

JUNE  
**20**



# **SPE DETROIT**

## **Annual Golf Outing**



## **Bay Pointe Golf Club**

**4001 Haggerty Rd., West Bloomfield, MI**

**When: Tuesday, June 20, 2023**

**Time: 11:00am - Shot Gun Start!**

**Format: Four person scramble, best ball.**

**Cost: \$130/person, \$600/Foursome includes Hole Sponsor, Optional Hole Sponsor Only \$125.**

**Includes: 18 Holes & Cart, Door Prize, Grilled Lunch, & Dinner (Full Service sit down), Contest and Prizes!**

**Reserve Your Spot: Contact: Karen Rhodes-Parker**

**Email: [karen@spedetroit.com](mailto:karen@spedetroit.com)**

**Phone: 248-244-8993 ext. 3**

**[www.spedetroit.org](http://www.spedetroit.org)**

DETROIT MARRIOTT TROY • 200 W BIG BEAVER • TROY MI 48084  
OCTOBER 1-4, 2023



# TPO® 2023 GLOBAL AUTOMOTIVE CONFERENCE

Troy, MI • October 1-4, 2023  
Powered by SPE Detroit Section

## ENGINEERED POLYOLEFINS FOR THE MOBILITY EVOLUTION

AUTO-TPO.COM



# CALL FOR PRESENTATIONS

ABSTRACTS DUE: APRIL 17, 2023 • PRESENTATIONS DUE: JULY 17, 2023

2022 SPE TPO GLOBAL AUTOMOTIVE ENGINEERED  
POLYOLEFINS CONFERENCE SPONSORS:

### PLATINUM SPONSORS



### GOLD SPONSORS



### EXHIBITORS



LANYARD SPONSOR



ADVERTISOR ONLY



## ATTEND THE WORLD'S LEADING ENGINEERED POLYOLEFINS FORUM

Now in its third decade, the Conference is the world's leading engineered polyolefins forum typically featuring 70+ technical presentations, select keynote speakers, networking, receptions, & exhibits that highlight advances in polyolefin materials, processes, and applications technologies as well as a growing range of thermoplastic elastomers (TPEs) and thermoplastic vulcanizates (TPVs). This year's event is a full live in-person program with some planned virtual elements, promising an even greater global participation. The conference will be held **October 1-4, 2023**, at the Detroit Marriot Troy Hotel (Troy, MI USA).

## PRESENT TO A LARGE GROUP OF DECISION MAKERS IN ENGINEERED POLYOLEFINS

The *SPE TPO Global Automotive Engineered Polyolefins Conference* typically draws over 600 attendees from 20 countries on 4 continents who are vitally interested in learning about the latest in rigid and elastomeric TPO as well as TPE and TPV technologies. A full third of conference attendees work for a transportation OEM, and nearly 20% work for a tier integrator. Few conferences of any size can provide this type of networking opportunity or put you before such an engaged, global audience interested in hearing the latest olefin advances. Interested in presenting your latest research? Abstracts are due **April 17, 2023**, and Papers/Presentations on **July 17, 2023**. Email abstracts/papers to [TPOpapers@auto-tpo.com](mailto:TPOpapers@auto-tpo.com).

## SHOWCASE YOUR PRODUCTS & SERVICES AT THE WORLD'S LARGEST AUTOMOTIVE ENGINEERED POLYOLEFINS FORUM

Many sponsorship packages are available. Companies interested in showcasing their products and/or services should contact [karen@auto-tpo.com](mailto:karen@auto-tpo.com).

### FOR MORE INFORMATION

[www.auto-tpo.com](http://www.auto-tpo.com) or [www.spedetroit.org](http://www.spedetroit.org)

Ph: +1.248.244.8993, Ext 3 or email: [karen@auto-tpo.com](mailto:karen@auto-tpo.com)  
SPE Detroit Section, 5750 New King Dr., Ste. 120, Troy MI, 48098

### FOR ADVERTISEMENT PLEASE CONTACT

[karen@auto-tpo.com](mailto:karen@auto-tpo.com)

# 2023 SPONSORS

Borealis Automotive

## Design for the products of tomorrow

Borealis is one of the world's leading providers of advanced and circular polyolefin solutions in automotive:

- Battery Box light-weighting
- Advanced cooling system solutions
- Next generation exterior body panels
- Improved aesthetics for bumpers/fascia
- Innovative lighting concepts

For more information go to [www.borealisgroup.com](http://www.borealisgroup.com) or contact [kevin.degrood@borealisgroup.com](mailto:kevin.degrood@borealisgroup.com)

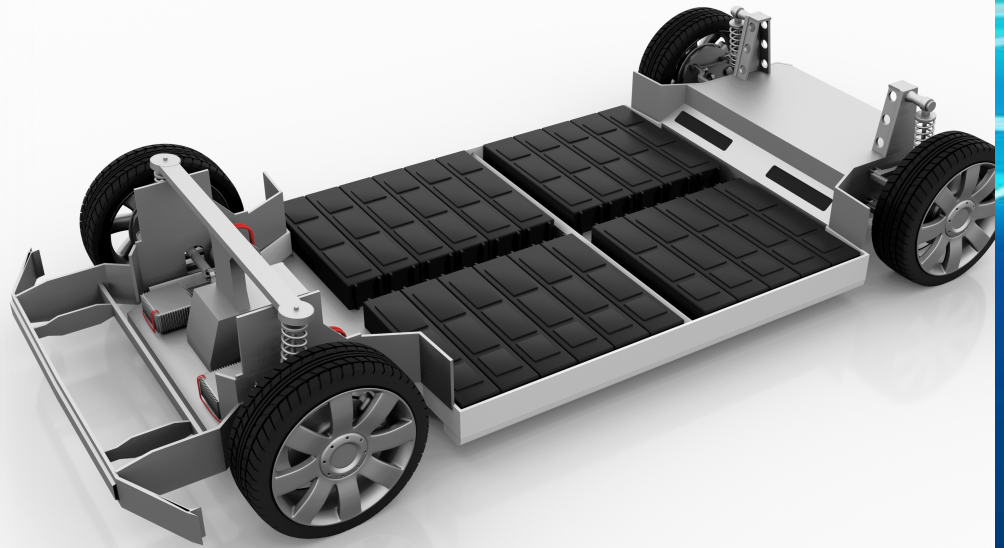

DRIVING THE AUTO INDUSTRY  
**FORWARD.**

Formulate Great.™  
[washingtonpenn.com](http://washingtonpenn.com)

**BOOTH #18**

Light Weighting | Sustainable Renewable Content | Engineering Resin & Metal Replacements | Segment Leading Polypropylene Compound Tech. | Noise Reduction & Impact Solutions | And More

# PLASTICS: CHARGING INTO THE AUTOMOTIVE REVOLUTION



**AUTOMOTIVE INNOVATION AWARDS COMPETITION & GALA**  
HONORING THE BEST IN AUTOMOTIVE PLASTICS

**NOVEMBER 8, 2023**



## Call for Nominations

### MOST INNOVATIVE USE OF PLASTICS AWARDS

The Automotive Division of the Society of Plastics Engineers (SPE®) is announcing a “Call for Nominations” for its 52nd-annual **Automotive Innovation Awards Gala**, the oldest and largest recognition event in the automotive and plastics industries. This year’s Awards Gala will be held Wednesday, **NOVEMBER 8, 2023** at the Burton Manor in Livonia, Michigan. Winning part nominations (due by **September 8, 2023**) in 10 different categories, and the teams that developed them, will be honored with a **Most Innovative Use of Plastics** award. A **Grand Award** will be presented to the winning team from all category award winners.

#### SPONSORSHIP OPPORTUNITIES

This annual event currently draws over 800 OEM engineers, automotive and plastics industry executives, and media. A variety of sponsorship packages - including tables at the banquet, networking receptions, advertising in the program book, signage at the event and more are available. Contact Teri Chouinard of Intuit Group at [teri@intuitgroup.com](mailto:teri@intuitgroup.com).

For more info and to submit nominations, go to:

<https://speautomotive.com/spe-automotive-div-innovation-awards/>

#### CATEGORIES:

- BODY EXTERIOR
- BODY INTERIOR
- CHASSIS/HARDWARE
- ELECTRIC AND AUTONOMOUS VEHICLE SYSTEMS
- LIMITED EDITION/SPECIALTY VEHICLES AND AFTERMARKET
- MATERIALS
- POWERTRAIN
- PROCESS, ASSEMBLY & ENABLING TECHNOLOGIES
- SAFETY
- SUSTAINABILITY

## 2022 Sponsors

VIP RECEPTION & AFTERGLOW SPONSOR



MAIN RECEPTION SPONSOR



WINE & FLOWERS SPONSOR



GOLD SPONSORS



Plastics Division



SILVER SPONSORS



BRONZE SPONSORS



ADVERTISING SPONSORS



MEDIA / ASSOCIATION SPONSORS





# 2023 SPONSORS



Compound.  
Extrude.  
Innovate.

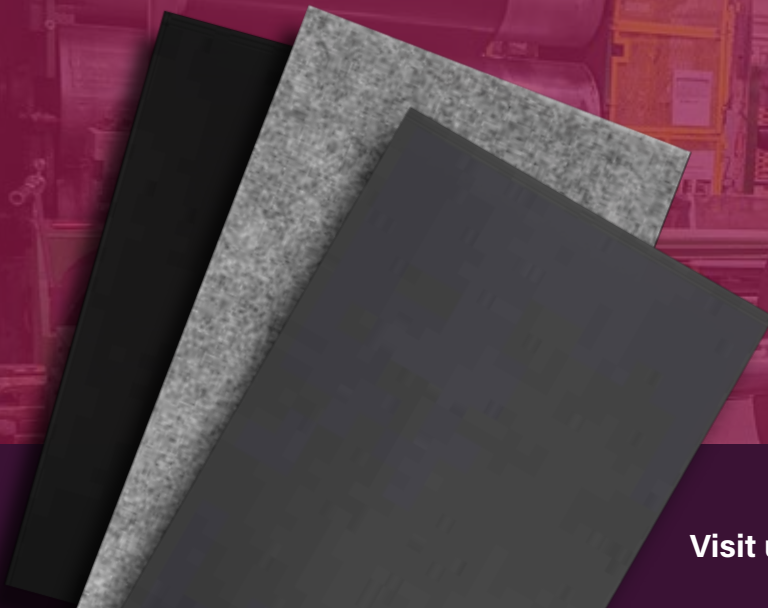

Filled NVH Barriers



Fire Retardant Polypropylene



Abrasion Resistant Surfaces

Visit us at Booth 19

1-800-866-8208  
highlandplastics.com



POLYMER FOCUSED SOLUTIONS FOR A SUSTAINABLE WORLD

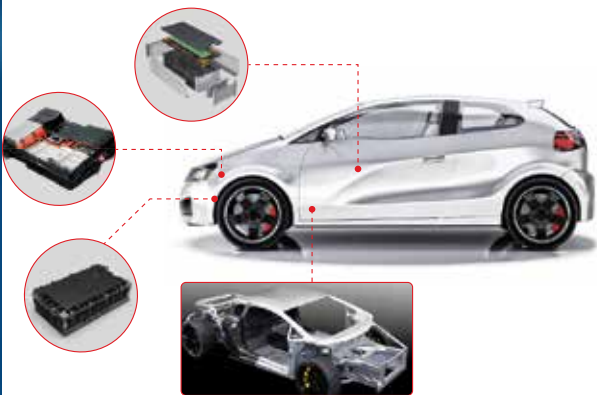

## MATERIAL SOLUTIONS FOR NEW ENERGY VEHICLES

### PRODUCT PORTFOLIO

- Flame Retardant Material
- Micro-Foamed Material
- Low Density Material
- Low Shrinkage Material
- Carbon Fiber Reinforced Material
- Pre-Colored Material
- Special Appearance Material

### BENEFITS

- Innovative Technologies
- Design Flexibility
- High Quality
- Light Weight
- Improved Productivity
- Increased Efficiency
- Lower Cost

🚀 LIGHT WEIGHT    💡 NEW TECHNOLOGIES    ⚙️ HIGH EFFICIENCY    💰 LOWER COST

[www.pret.com.cn](http://www.pret.com.cn)    [sales@pretgroup.com](mailto:sales@pretgroup.com)

©2022 PRET Advanced Materials, LLC | The PRET name and logo are registered trademarks of PRET Advanced Materials, LLC

# Thank You! TO OUR 2023 SPONSORS

## PLATINUM SPONSORS

— LANYARD SPONSOR —



— BAG SPONSOR —



## GOLD SPONSORS

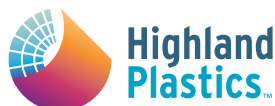

## EXHIBITORS



# SALUTE TO OUR SPONSORS

The 2023 SPE Electric and Autonomous Vehicles Conference would not exist without the gracious support of our sponsors. Hence, it is with great appreciation that we thank and acknowledge the contributions of our 2023 sponsors, exhibitors, and other patrons in making this event a success.

## PLATINUM SPONSOR

SABIC\* | Celanese+ | Lotte Chemical | Entec Polymers

## GOLD SPONSORS

Alterra | Ascend Performance Materials | BASF | Borealis  
Carbon Polymers | Covestro | Dow / PU & Olefin  
EMS-CHEMIE (North America) Inc. | Envalior | Highland Plastics  
Inteva Products | LG Chem America Inc. | LyondellBasell  
Mankiewicz | Momentive | PRET | Sirmax  
TMG | Trinseo | Washington Penn

## EXHIBITORS

Akro-Plastic GMBH | Arkema | Asahi Kasei | Imerys  
Kurz USA | NYCOA | Pinfa N. America | Radici Plastics USA  
Sustainable Resins LLC | Synergeering

\* Lanyard Sponsor + Bag Sponsor